

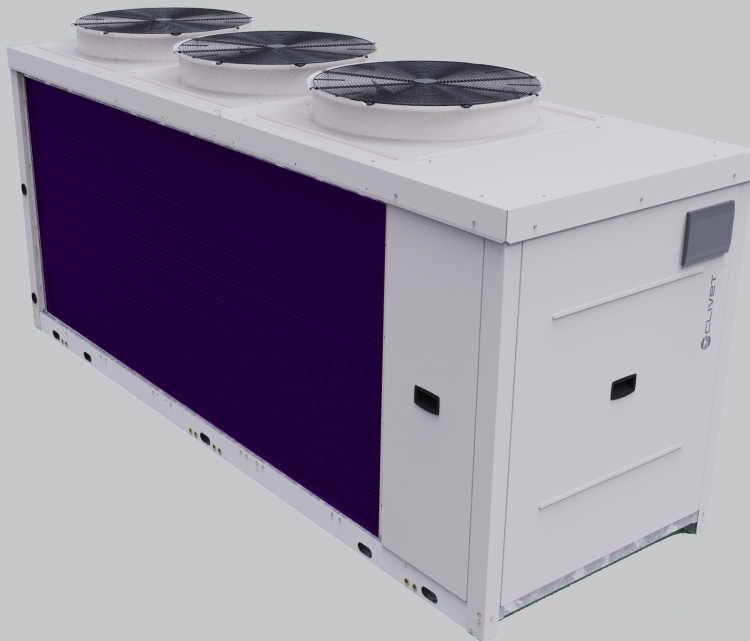

*Air source inverter heat pump
for outdoor installation*

ELFOENERGY SHEEN EVO

WSAN-YSi 10.1 - 40.2 RANGE



TECHNICAL BULLETIN



SIZE	10.1	12.1	14.1	16.2	18.2	22.2	30.2	35.2	40.2
COOLING CAPACITY KW	25,3	28,2	32,0	48,6	54,0	62,0	68,9	79,8	88,4
HEATING CAPACITY KW	22,3	25,8	29,0	42,0	48,0	55,0	77,5	86,0	96,1

Page

3	Features and benefits
4	Standard unit technical specifications
5	Unit configuration
6	Built-in options
7	Options separately supplied
8	General technical data
16	Hydronic assembly
21	Performances
39	System configurations
41	Dimensional drawing



Clivet is taking part in the EUROVENT certification programme up to 1.500 kW. The products concerned appear in the certified products list of the EUROVENT www.eurovent-certification.com site.

Features and benefits

ELFOEnergy Sheen EVO series is the new air cooled heat pump, equipped with Full DC Inverter technology and R-32 refrigerant, for outdoor installation. It is available from 20 kW up to 97 kW and is the most effective and valuable solution both in terms of capital investment and running costs.

Energy Efficiency

Class A Eurovent at full load in heating and in cooling.
SCOP up to 4,30, which reaches the A++ class according to EU Regulation 811/2013 (ErP) with low water temperature (LWT 35°C).
SEER up to 4,64 which makes it extremely competitive even compared to the cooling only units.
Capacity modulation from 30% to 100%.

Wide operating range

Outdoor air temperature	max	min
• heating mode	30 °C	-14 °C
• domestic hot water mode	43 °C	-14 °C
• cooling mode	48 °C	-10 °C
Outlet water temperature	max	min
• heating mode	54 °C	15 °C
• domestic hot water mode	54 °C	15 °C
• cooling mode	20 °C	0 °C

Functionality

- Management and production of domestic hot water up to 55 °C
- Climate compensation with outdoor temperature
- Double set-point adjustable
- Additional heating source management.

SILENT mode:

- speed reduction of compressors and fans
- three levels of silence: standard mode, silenced, super silenced

Modular design

ELFOEnergy Sheen EVO has been designed for modularity. It is possible to connect up to 16 units in a local network, reaching a maximum capacity of 1550 kW. The combinations can also take place with different capacity units. The modular system, obtained by combining several modules, preserves the strengths of the single module, but multiplies the advantages:

- Increased system efficiency
- Higher reliability
- Simplified handling and installation
- Quick and easy maintenance
- Scalability

Application Versatility

All the main system components are integrated in the unit, assuring the best reliability and an easy installation:

- Hydronic assembly with 1 inverter pump
- Hydronic assembly with 1 on/off pump
- 3-way valve for the domestic hot water production
- System storage tank: 140 liters (size 10.1 ÷ 14.1), 180 liters (size 16.2 ÷ 22.2) or 275 liters (30.2 ÷ 40.2).

Technology

The technical solutions adopted place ELFOEnergy Sheen EVO on top of its category:

- DC inverter technology on compressors and fans
- Electronic expansion valve
- Flow switch
- Hydrophilic battery

Tax credit

Due to its high efficiency, ELFOEnergy Sheen EVO may be eligible for heat pump subsidies in Your Country.

Compressors

Inverter controlled twin rotary-type hermetic compressor equipped with a motor protection device for overheating, overcurrents and excessive temperatures of the supply gas. It is installed on anti-vibration mounts and it is equipped with oil charge. The compressor is wrapped in a sound-absorbing hood, that reduces its sound emissions.

A crankcase heater, which starts automatically, keeps the oil from being diluted by the refrigerant when the compressor stops. For sizes from 30.2 to 40.2 the compressor is scroll.

Structure

Structure and base made entirely of sturdy sheet steel, thickness from 12/10 to 20/10, hot dip galvanized and painted, for the parts in view, with polyester powder RAL9001 that guarantees excellent mechanical characteristics and high corrosion strength over time.

Panelling

External paneling made of sheet steel, thickness 12/10, hot dip galvanized and painted with polyester powder RAL9001 that guarantees excellent mechanical characteristics and high corrosion strength over time. The panels can be easily removed to fully access internal components.

Internal exchanger

Direct expansion heat exchanger, braze-welded AISI 316 stainless steel plates, in pack without seals using copper as the brazing material, with low refrigerant charge and large exchange surface, complete with:

- external thermal insulation no-condensation, thickness 17 mm, in expanded polypropylene (EPP);
- antifreeze heater to protect the water side exchanger, preventing the formation of frost if the water temperature falls below a set value.

The water connections of the exchanger are quick-release with splined joint (Victaulic).

External exchanger

Direct expansion finned coil exchanger made with inner grooved copper pipes placed on staggered rows mechanically expanded to better adhere to the fin collar. The fins are made from aluminum with a hydrophilic treatment.

A particular refrigerant circuit prevents the formation of frost on the base of the exchanger during winter operation.

Fan

Axial fans with sickle profile blades terminating ABS ASG-20 resin reinforced with 20% glass fiber, directly coupled to the electronic controlled motor (IP23), driven by the magnetic switching of the stator.

The brushless technology and the special supply increase both the life expectancy and the efficiency. As a result the electric consumption is reduced up to 50%. Fans are housed in aerodynamically shaped structures to increase efficiency and reduce noise level. The assembly is protected by accident prevention guards. Both fans and prevention guards are designed with CFD technology. Supplied with variable speed control.

Refrigeration circuit

Refrigeration circuit with:

- electronic expansion valve;
- 4-way reverse cycle valve;
- high pressure safety switch;
- low pressure safety switch;
- liquid receiver;
- liquid separator;
- oil separator;
- pressure transducer;
- high temperature protection pressure switch;
- temperature sensors;
- low pressure safety valve;
- economizer exchanger (only for sizes 30.2 ÷ 40.2).

Electrical panel

The capacity section includes:

- terminals main power;
- auxiliary components protection fuse;
- AC filter on power supply;
- power supply phase sequence protection;
- protection for compressor over current;
- protection for compressor overload;
- sensor malfunction protection.

The control section includes:

- compressor overload protection and timer;
- relay for remote cumulative fault signal;
- defrosting cycle optimization;
- condenser control;
- dry contact for remote ON/OFF;
- dry contact for remote HEAT/COOL mode control.

The control keypad includes:

- wired controller with dot-matrix display;
- multifunction keys for ON/OFF control;
- cold, hot and auto operation mode;
- display and alarm reset;
- daily or weekly schedule;
- separated power adaptor for remote use;
- serial port with modbus port (RS485) for remote communication.

Water circuit

- Safety valve 6 bar
- Flow switch
- Antifreeze water flow heater
- Drain valve
- Temperature sensors

Test

Unit subjected to factory-tested in specific steps and test pressure of the piping of the refrigerant circuit (with nitrogen and hydrogen), before shipping them.

Unit configuration

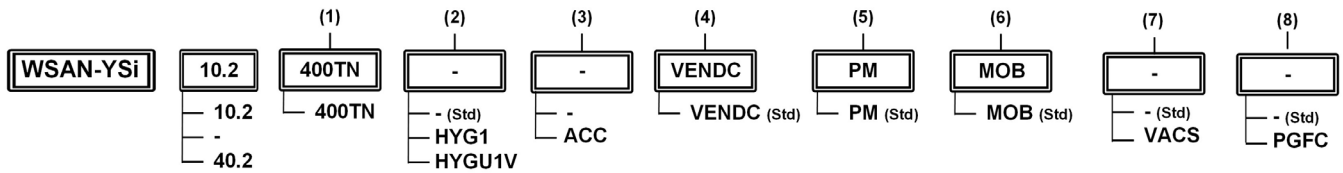

(1) Voltage

400TN - Supply voltage 400/3/50 + N (standard)

(2) User side hydronic unit

(-) not required (standard)

HYG1 - Hydronic assembly with 1 ON/OFF pump

HYGU1V - User side hydronic assembly with 1 inverter pump

(3) Storage tank

(-) not required (standard)

ACC - Storage tank

(4) Fans

VENDC - DC high efficiency fans (standard)

(5) Phase monitor

PM - Phase monitor (standard)

(6) Serial communication module

MOB - RS485 Serial port with Modbus protocol

(7) Domestic hot water valve

(-) not required (standard)

VACS - DHW switching valve

(8) Protection grill

(-) not required (standard)

PGFC - Finned coil protection grill

HYG1

Hydronic group with 1 ON/OFF pump

Hydronic unit made of 1 centrifugal electric pump, with body and propeller made in AISI 304 steel. The electric pump is equipped with three-phase electric motor with IP55 protection and complete with heat formed insulating casing. The water connection are 1" 1/2 Victaulic for the sizes 10.1 ÷ 14.1 and 2" Victaulic for the sizes 16.2 ÷ 40.2. Hydronic unit performance is available on page 15 and 16.

HYGU1V

User side hydronic group with 1 inverter pump

Hydronic unit made of a centrifugal electric pump, adjusted by way of inverter, body and propeller made in AISI 304 steel. The electric pump is equipped with three-phase electric motor with IP55 protection and complete with heat formed insulating casing. The water connection are 1" 1/2 Victaulic for the sizes 10.1 ÷ 14.1 and 2" Victaulic for the sizes 16.2-40.2. Hydronic unit performance is available on page 17 and 18.

ACC

Storage tank

Option supplied built-in the unit. Steel storage tank complete with double layer covering with closed-cell insulation, stainless steel anti-freeze immersion resistance, bleed valve, draw off cock, cast-iron shut-off butterfly valve with quick connections and activation lever with a mechanical calibration lock at the evaporator output, quick connections with insulated casing.

The storage tank capacity is 145 liters for size 10.1, 12.1 and 14.1.
The storage tank capacity is 160 liters for size 16.2, 18.2 and 22.2.
The storage tank capacity is 275 liters for size 30.2, 35.2 and 40.2.

⚠ Not available with option VACS at the same time.

VACS

DHW switching valve

The 3-way diverter valve deviating the water flow towards a heating storage tank for domestic water is installed on the side of the unit.

If the temperature of the ACS is under the set-point, ELFOEnergy Sheen EVO changes to ACS production mode (priority compared to other operational modes can be set).

The unit controller closes a digital output driving the flow deviation valve from the storage system until it reaches the ACS set-point set on the user interface.

The water connections are 2" Victaulic.

DHW switching valve pressure drop

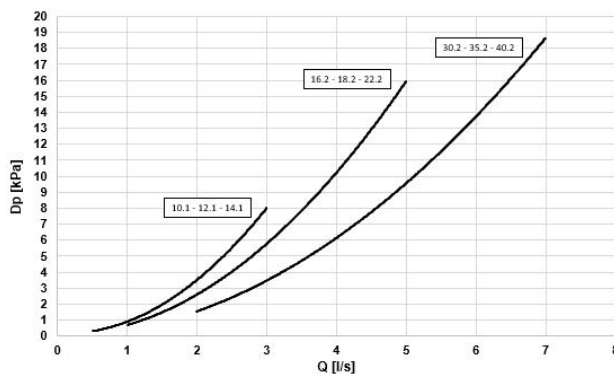

Q = Water flow rate [l/s]
Dp = Water side pressure drops [kPa]

⚠ The maximum nominal pressure of the unit with the 3-way valve option is 6bar

⚠ Not available with option ACC at the same time.

SNB

Main switch on board

Main switch I=67A/AC23 for the unit ON/OFF and M40 fairleads, mounted on board.

PGFC

Finned coil protection grill

The grilles protect the external coil from accidental contact with objects or persons. Ideal for installation in places where persons can pass from, such as car parks, terraces, etc.

FEMC

EMC filtering for residential, commercial and light industry environments (direct connection to the public grid).

It allows the unit to be installed in residential, commercial or light industrial environments, reducing electromagnetic interference.

Options separately supplied

IFWX

Steel mesh strainer on the water side

The device stops the exchanger from being clogged by any impurities which are in the hydraulic circuit. The mechanical steel mesh strainer must be placed on the water input line. It can be easily dismantled for periodical maintenance and cleaning. Filter fittings are Victaulic type by 2".

Steel mesh strainer pressure drops

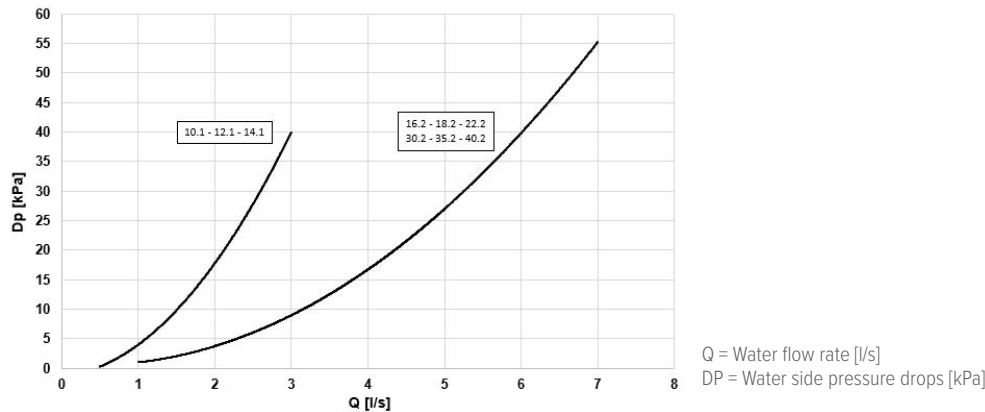

AVIBX

Anti-vibration mount support

The rubber antivibration mounts are attached in special housing on the support frame and serve to smooth the vibrations produced by the unit thus reducing the noise transmitted to the support structure.

AMMSX

Anti-seismic spring antivibration mounts

The anti-seismic spring antivibration mounts must be fastened in special housings on the supporting metal struts.

The containment structure is designed to ensure high resistance multidirectional forces acting on the surface of the unit in the presence of wind and / or telluric movements.

The antivibration mounts have been tested according to ANSI/ASHRAE 171-2008 standard (Method of Testing Seismic Restraint devices for HVAC&R Equipment). The performance levels and the test methodology have been validated and certified by Lloyd's Register.

⚠ Installation is a responsibility of the Customer.

SNATEX

Non ATEX main switch for remote external installation

Watertight box IP54 containing n°1 main switch I=67A/AC23 for the unit ON/OFF and M40 fairleads.

REUMAX

Advanced remote control module

Multifunction board in watertight box IP56 for the advanced use of digital inputs and Modbus gateway with configurable baud rate.

The available digital inputs allow the following functions from remote:

- remote on/off
- heat/cool (summer/winter commutation)
- DHW activation (for heat pump version only)
- double set-point management
- silent mode or super silent mode activation (selectable on user interface)

The board does not allow the contemporary use of digital inputs and Modbus signal.

Performance

SIZE		10.1	12.1	14.1	16.2	18.2	22.2	30.2	35.2	40.2
Radiant panels										
Heating										
Heating capacity (EN 14511:2018)	1,8 kW	25,3	28,2	32,0	48,6	54,0	62,0	77,5	86,0	96,1
COP (EN 14511:2018)	2	4,17	4,25	4,16	4,01	4,01	3,90	4,15	4,01	3,75
ErP Space Heating Energy Class - AVERAGE Climate - W35	7	A++	A++	A++	A++	A++	A++	A++	A++	A++
SCOP - MEDIUM climate- W35	9	4,30	4,25	4,24	3,91	3,90	3,87	4,07	4,06	4,04
$\eta_{s,h}$ - MEDIUM climate - W35	11 %	169	167	167	153	153	152	160	159	159
SCOP - COLD climate - W35	9	3,03	3,14	3,13	2,88	2,88	2,88	3,20	3,17	3,22
$\eta_{s,h}$ - COLD climate- W35	11 %	118	123	122	112	112	112	125	124	126
SCOP - HOT climate - W35	9	4,26	4,32	4,31	3,81	3,82	3,85	4,11	4,09	3,94
$\eta_{s,h}$ - HOT climate - W35	11 %	167	170	169	149	150	151	162	160	155
Cooling										
Cooling capacity (EN 14511:2018)	4,8 kW	29,9	34,6	38,9	57,7	66,0	75,6	95,4	112	119
EER (EN 14511:2018)	5	4,28	3,94	3,62	3,83	3,53	3,23	3,88	3,41	3,29
Water flow-rate	4 l/s	1,43	1,66	1,86	2,76	3,15	3,61	4,51	5,27	5,66
User side exchanger pressure drops	4 kPa	40	50	63	37	49	62	56,0	76,5	86,2
Terminal units										
Heating										
Heating capacity (EN 14511:2018)	3 kW	24,3	27,1	31,4	48,6	54,0	62,0	73,4	84,0	97,3
COP (EN 14511:2018)	2	3,30	3,27	3,20	3,32	3,26	3,10	3,19	3,19	3,09
Cooling										
Cooling capacity (EN 14511:2018)	6 kW	22,3	25,8	29,0	42,0	48,0	55,0	68,9	79,8	88,4
EER (EN 14511:2018)	5	3,02	2,84	2,80	2,69	2,63	2,64	3,09	2,81	2,65
SEER	9	4,63	4,64	4,63	4,00	3,99	4,01	4,14	4,04	3,94
$\eta_{s,c}$	12 %	182	183	182	157	157	157	163	159	155
SEPR	10	6,12	6,1	6,09	5,64	5,61	5,47	6,14	5,81	5,63
Water flow-rate	6 l/s	1,06	1,23	1,39	2,01	2,29	2,63	3,22	3,81	4,25
User side exchanger pressure drops	6 kPa	23	29	41	28	32	36	31,5	42,4	52,2

The Product is compliant with the ErP (Energy Related Products) European Directive. It includes the Commission delegated Regulation (EU) No 811/2013 (rated heat output \leq 70 kW at specified reference conditions) and the Commission delegated Regulation (EU) No 813/2013 (rated heat output \leq 400 kW at specified reference conditions)
Contains fluorinated greenhouse gases (GWP 675)

1. Entering/leaving water temperature user side 30/35 °C, Entering external exchanger air temperature 7 °C (R.H. = 85%)
2. COP (EN 14511:2018) Heating performance coefficient. Ratio between delivered heating capacity and power input in compliance with EN 14511:2018. The overall power absorbed is calculated by adding the power absorbed by the compressor + the power absorbed by the fan - the percentage value of the fan to overcome external pressure drop + the power absorbed by the pump - the percentage value of the pump to overcome pressure drop outside + the power absorbed by the auxiliary electrical circuit
3. Entering/leaving water temperature user side 40/45 °C, Entering external exchanger air temperature 7 °C (R.H. = 85%)
4. Entering/leaving water temperature user side 23/18 °C, Entering external exchanger air temperature 35 °C
5. EER (EN 14511:2018) cooling performance coefficient. Ratio between delivered cooling capacity and power input in compliance with EN 14511:2018. The overall power absorbed is calculated by adding the power absorbed by the compressor + the power absorbed by the fan - the percentage value of the fan to overcome external pressure drop + the power absorbed by the pump - the percentage value of the pump to overcome pressure drop outside + the power absorbed by the auxiliary electrical circuit.
6. User side entering/leaving water temperature 12/7 °C, external exchanger entering air 35 °C
7. Seasonal Space Heating Energy Efficiency Class according to Commission delegated Regulation (EU) No 811/2013. W = Water outlet temperature (°C)
8. Data referred to unit operation with inverter frequency optimized for this application.
9. Data calculated according to the EN 14825:2018 Regulation
10. Seasonal energy efficiency in heating EN 14825:2018
11. Seasonal energy efficiency in cooling EN 14825:2018

General technical data

Construction

SIZE		10.1	12.1	14.1	16.2	18.2	22.2	30.2	35.2	40.2	
Compressor											
Type of compressors		Rotary Inverter					Scroll inverter				
Refrigerant		R32									
No. of compressors	Nr	1	1	1	2	2	2	2	2	2	
Oil charge	l	2,3	2,3	2,3	4,6	4,6	4,6	6	6	6	
Refrigerant Charge	Kg	7,9	7,9	7,9	14	14	14	17,5	17,5	17,5	
No. of circuits	Nr	1	1	1	1	1	1	1	1	1	
User side exchanger											
Type of internal exchanger	1	PHE									
Water content	l	2,44	2,44	2,44	5,17	5,17	5,17	7,8	7,8	7,8	
External Section Fans											
Type of fans		Brushless DC									
No. of fans		1	1	1	2	2	2	3	3	3	
Standard airflow	m ³ /h	12500	12500	12500	24000	24000	24000	36000	36000	36000	
Installed unit power	kW	0,75	0,75	0,75	1,2	1,2	1,2	0,9	0,9	0,9	
Water circuit											
Maximum water side pressure	kPa	1000	1000	1000	1000	1000	1000	1000	1000	1000	
Minimum circuit water volume in heating	l	171	178	185	326	340	358	620	620	620	
Minimum circuit water volume in cooling	l	70	75	80	140	145	150	200	200	200	
Total internal water volume	l	5,44	5,44	5,44	10,3	10,3	10,3	15,6	15,6	15,6	
Power supply											
Standard power supply		400/3/50+N									

1. PHE = Plate exchanger

Electrical data

SIZE		10.1	12.1	14.1	16.2	18.2	22.2	30.2	35.2	40.2
F.L.A. Full load current at max admissible conditions										
F.L.A. - Total	A	20,0	20,0	20,0	40,50	40,50	40,50	60,2	60,2	60,2
F.L.I. Full load power input at max admissible conditions										
F.L.I. - Total	kW	12,08	12,08	12,08	24,50	24,50	24,50	42,0	42,0	42,0
M.I.C. Maximum inrush current										
M.I.C. - Total	A	20,0	20,0	20,0	40,50	40,50	40,50	60,2	60,2	60,2

Power supply 400/3/50 (+ NEUTRAL) +/- 10%.

Maximum Phase Unbalance: 2%.

For non standard voltage please contact Clivet technical office

Sound levels - Standard mode

SIZE	Sound power level								Sound pressure level	Sound power level
	Octave band (Hz)									
	63	125	250	500	1000	2000	4000	8000	dB(A)	dB(A)
10.1	63	65	68	71	72	67	60	48	59	75
12.1	62	69	70	72	73	68	62	51	60	76
14.1	69	69	70	73	74	69	63	51	61	77
16.2	66	75	74	78	78	72	65	54	64	81
18.2	65	73	76	78	78	74	66	56	65	82
22.2	66	73	76	78	78	74	66	56	65	82
30.2	73	69	73	76	80	75	69	57	65	82
35.2	85	86	79	76	80	75	69	57	65	83
40.2	88	89	82	76	80	75	69	59	66	83

Sound levels refer to units with maximum test conditions.

For maximum capacity supplied in silent mode, a correction factor of 0,90 shall be used.

The sound pressure level refers to a distance of 1 meter from the outer surface of the unit operating in open field.

Noise levels are determined using the tensiometric method (UNI EN ISO 9614-2)

Data referred to the following conditions in Heating:

- internal exchanger water = 30/35 °C

- ambient temperature 7/6 °C

Data referred to the following conditions in cooling:

- internal exchanger water = 12/7 °C

- ambient temperature 35 °C

Sound levels - Silenced mode

SIZE	Sound power level								Sound pressure level	Sound power level
	Octave band (Hz)									
	63	125	250	500	1000	2000	4000	8000	dB(A)	dB(A)
10.1	65	65	67	70	71	70	60	49	58	74
12.1	65	65	67	70	71	70	60	49	58	74
14.1	65	65	67	70	71	70	60	49	58	74
16.2	58	67	67	69	70	68	60	52	57	74
18.2	58	67	67	69	70	68	60	52	57	74
22.2	58	67	67	69	70	68	60	52	57	74
30.2	63	68	71	71	71	68	56	58	58	75
35.2	63	68	71	71	71	68	56	58	58	75
40.2	63	68	71	71	71	68	56	58	58	75

Sound levels refer to units with maximum test conditions.

For maximum capacity supplied in silent mode, a correction factor of 0,90 shall be used.

The sound pressure level refers to a distance of 1 meter from the outer surface of the unit operating in open field.

Noise levels are determined using the tensiometric method (UNI EN ISO 9614-2)

Data referred to the following conditions in Heating:

- internal exchanger water = 30/35° C

- ambient temperature 7/6° C

Data referred to the following conditions in cooling:

- internal exchanger water = 12/7°C

- ambient temperature 35°C

General technical data

Sound levels - Super silenced mode

SIZE	Sound power level								Sound pressure level dB(A)	Sound power level dB(A)
	Octave band (Hz)									
	63	125	250	500	1000	2000	4000	8000		
10.1	51	62	64	68	68	63	56	45	55	71
12.1	51	62	64	68	68	63	56	45	55	71
14.1	51	62	64	68	68	63	56	45	55	71
16.2	54	67	63	66	66	65	58	51	54	71
18.2	54	67	63	66	66	65	58	51	54	71
22.2	54	67	63	66	66	65	58	51	54	71
30.2	55	74	71	68	66	66	64	55	55	73
35.2	55	74	71	68	66	66	64	55	55	73
40.2	55	74	71	68	66	66	64	55	55	73

Sound levels refer to units with maximum test conditions.

For maximum capacity supplied in silent mode, a correction factor of 0,85 shall be used.

The sound pressure level refers to a distance of 1 meter from the outer surface of the unit operating in open field.

Noise levels are determined using the tensiometric method (UNI EN ISO 9614-2)

Data referred to the following conditions in Heating:

- internal exchanger water = 30/35 °C

- ambient temperature 7/6 °C

Data referred to the following conditions in cooling:

- internal exchanger water = 12/7°C

- ambient temperature 35 °C

Sound levels - At maximum conditions

SIZE	Sound power level								Sound pressure level dB(A)	Sound power level dB(A)
	Octave band (Hz)									
	63	125	250	500	1000	2000	4000	8000		
10.1	63	67	72	75	76	71	64	54	63	79
12.1	63	67	72	75	76	71	64	54	63	79
14.1	63	67	72	75	76	71	64	54	63	79
16.2	68	74	79	79	81	76	69	59	67	84
18.2	68	74	79	79	81	76	69	59	67	84
22.2	68	74	79	79	81	76	69	59	67	84
30.2	88	89	82	76	80	75	69	59	66	84
35.2	88	89	82	76	80	75	69	59	66	84
40.2	88	89	82	76	80	75	69	59	66	84

Sound levels refer to units with maximum test conditions.

The sound pressure level refers to a distance of 1 meter from the outer surface of the unit operating in open field.

Noise levels are determined using the tensiometric method (UNI EN ISO 9614-2)

Operating range

Cooling - Size 10.2 - 40.2

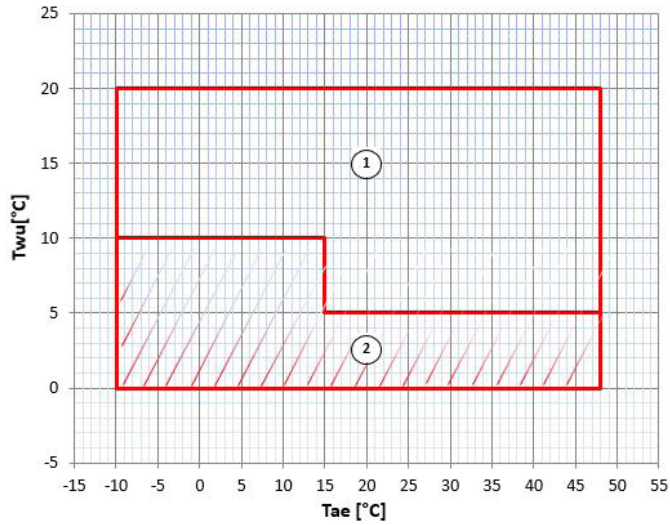

T_{wu} [°C] = Leaving exchanger water temperature
T_{ae} [°C] = External exchanger inlet air temperature

1. Normal operating range.
2. Operating range where the use of ethylene glycol is mandatory in relation to the temperature of the water at the outlet of the user side exchanger.

Heating - Size 10.2 - 22.2

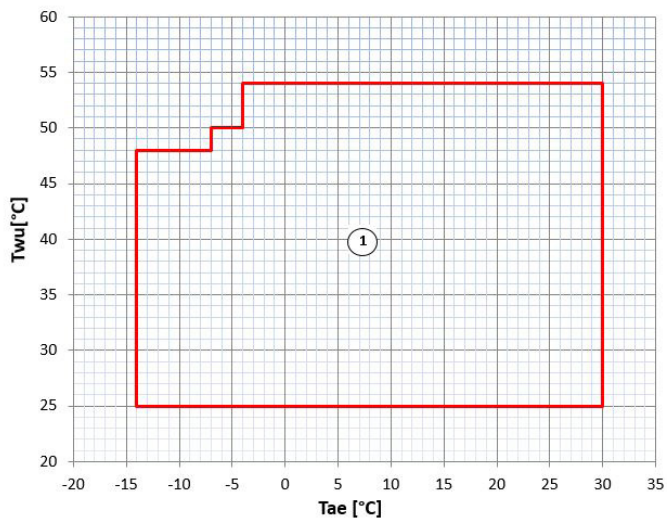

T_{wu} [°C] = Leaving exchanger water temperature
T_{ae} [°C] = External exchanger inlet air temperature

1. Normal operating range.

Heating - Size 30.2 - 40.2

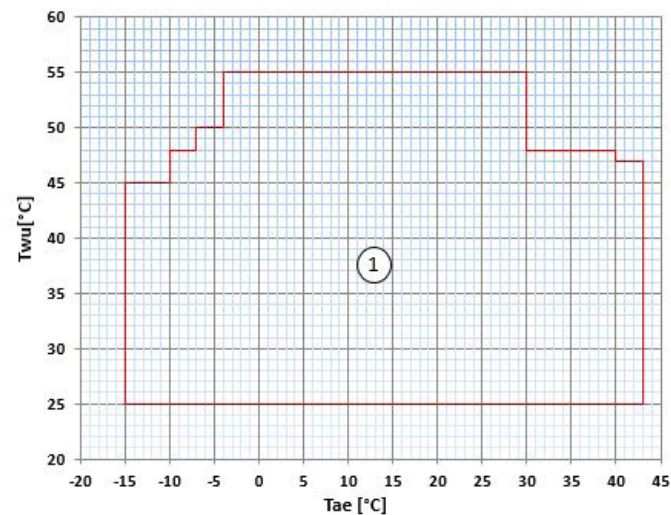

T_{wu} [°C] = Leaving exchanger water temperature
T_{ae} [°C] = External exchanger inlet air temperature

1. Normal operating range.

General technical data

DHW - Size 10.2 - 22.2

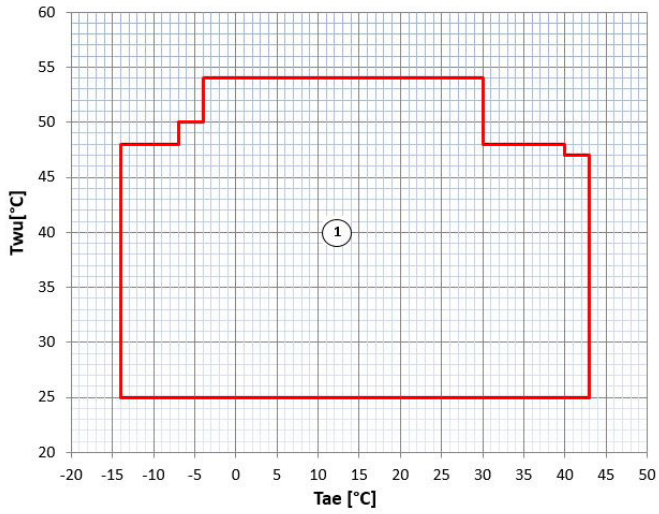

T_{wu} [°C] = Leaving exchanger water temperature
T_{ae} [°C] = External exchanger inlet air temperature

1. Normal operating range.

DHW - Size 30.2 - 40.2

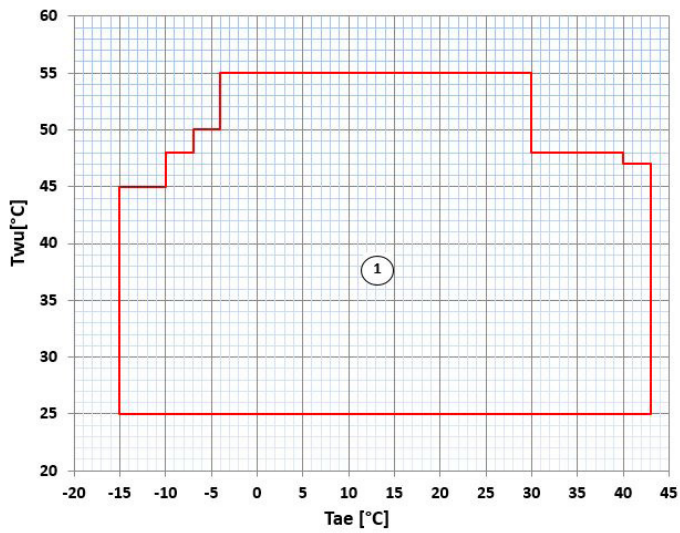

T_{wu} [°C] = Leaving exchanger water temperature
T_{ae} [°C] = External exchanger inlet air temperature

1. Normal operating range.

Performance correction factors- Silenced Mode

SIZE		10.1	12.1	14.1	16.2	18.2	22.2	30.2	35.2	40.2
Cooling										
Cooling capacity factor	Nr	0,90	0,90	0,90	0,90	0,90	0,90	0,93	0,93	0,93
Total power input factor	Nr	1,00	1,00	1,00	1,00	1,00	1,00	1,00	1,00	1,00
EER factor	Nr	0,90	0,90	0,90	0,90	0,90	0,90	0,93	0,93	0,93
Heating										
Heating capacity factor	Nr	0,92	0,92	0,92	0,92	0,92	0,92	0,95	0,95	0,95
Total power input factor	Nr	0,92	0,92	0,92	0,92	0,92	0,92	0,95	0,95	0,95
COP factor	Nr	1,00	1,00	1,00	1,00	1,00	1,00	1,00	1,00	1,00

Performance correction factors - Super Silenced Mode

SIZE		10.1	12.1	14.1	16.2	18.2	22.2	30.2	35.2	40.2
Cooling										
Cooling capacity factor	Nr	0,85	0,85	0,85	0,85	0,85	0,85	0,88	0,88	0,88
Total power input factor	Nr	1,00	1,00	1,00	1,00	1,00	1,00	1,02	1,02	1,02
EER factor	Nr	0,85	0,85	0,85	0,85	0,85	0,85	0,86	0,86	0,86
Heating										
Heating capacity factor	Nr	0,87	0,87	0,87	0,87	0,87	0,87	0,90	0,90	0,90
Total power input factor	Nr	0,87	0,87	0,87	0,87	0,87	0,87	0,90	0,90	0,90
COP factor	Nr	1,00	1,00	1,00	1,00	1,00	1,00	1,00	1,00	1,00

Correction factors for glycol use

% ETHYLENE GLYCOL BY WEIGHT		0%	10%	20%	30%	40%	50%
Freezing point	°C	0	-4	-9	-16	-23	-37
Correction factor for unit cooling capacity		1	0,984	0,973	0,965	0,96	0,95
Correction factor for flow rate		1	1,019	1,051	1,092	1,145	1,2
Correction factor for system pressure drop		1	1,118	1,268	1,482	1,791	2,1

The correction factors shown refer to water and glycol ethylene mixes used to prevent the formation of frost on the exchangers in the water circuit during inactivity in winter.

Fouling Correction Factors

M ² C/W	INTERNAL EXCHANGER	
	F1	FK1
0,44x10 (-4)	-	-
0,88x10 (-4)	0,96	0,99
1,76x10 (-4)	0,93	0,98

The cooling performance values provided in the tables are based on the external exchanger having clean plates (fouling factor 1). For different fouling factor values, multiply the performance by the coefficients shown in the table.

F1 = Cooling capacity correction factors

FK1 = Compressor power input correction factor

Overload and control device calibrations

		OPEN	CLOSE	VALUE
Refrigerant side				
High pressure safety pressure switch	kPa	4200	3200	-
Low pressure safety switch	kPa	140	300	-
Gas-liquid separator safety valve	kPa	-	-	4500
Compressor discharge high temperature safety thermostat	°C	75	115	-
Water side				
Antifreeze protection	°C	8	4	-
High pressure safety valve	kPa	-	-	600

General technical data

Internal exchanger pressure drop

The standard unit not include a hydronic group.

For the sizes 10.1, 12.1 and 14.1 the water connections are 1 1/2" Victaulic.

For the sizes 16.2, 18.2, 22.2, 30.2, 35.2 and 40.2 the water connections are 2" Victaulic.

Internal exchanger pressure drop curves

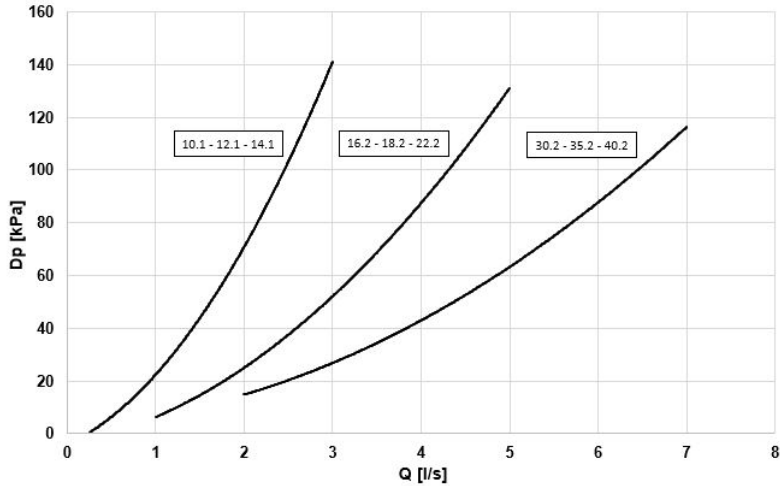

The pressure drops on the water side are calculated by considering an average water temperature at 7°C.

Q = Water flow rate [l/s]

DP = Pressure drops [kPa]

The water flow rate must be calculated with the following formula

$$Q \text{ [l/s]} = kWf / (4,186 \times DT)$$

kWf = Cooling capacity in kW

DT = Temperature difference between entering / leaving water

⚠ To the internal exchanger pressure drops must be added the pressure drops of the steel mesh mechanical filter that must be placed on the water input line. It is a device compulsory for the correct unit operation, and it is provided by Clivet as accessory.

Admissible water flow rates

Min. (Qmin) and max. (Qmax) water flow-rates admissibles for the correct unit operation.

SIZE		10.1	12.1	14.1	16.2	18.2	22.2	30.2	35.2	40.2
Minimum flow	[l/s]	0,9	0,9	0,9	1,8	1,8	1,8	2,9	2,9	2,9
Maximum flow	[l/s]	2,6	2,6	2,6	5,0	5,0	5,0	6,4	6,4	6,4

Unit with 1 ON/OFF pump (HYG1)

Configuration with 1 centrifugal electric pump, with housing and impeller made with AISI 304. The electric pump is equipped with three-phase electric motor with IP55-protection and complete with thermoformed insulated casing.

For the sizes 10.1, 12.1 and 14.1 the water connections are Victaulic type by 1 1/2".

For the sizes 16.2, 18.2, 22.2, 30.2, 35.2 e 40.2 water fittings are Victaulic type by 2".

Pump available pressure curves 10.2 - 22.2

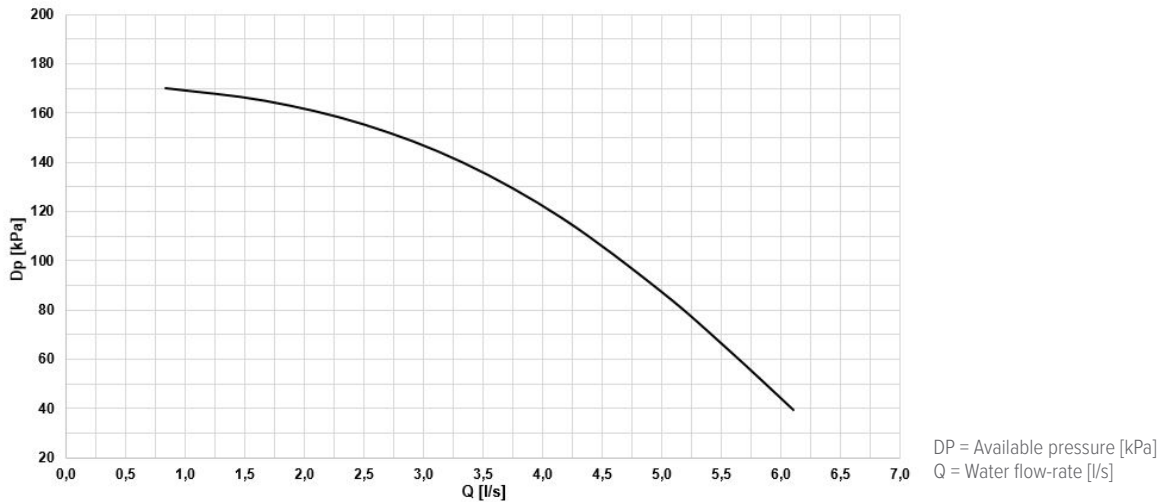

⚠ Caution: to obtain the available pressure values, you need to subtract the following from the head values represented in these diagrams:

- User side exchanger pressure drops
- IFVX accessory – Steel mesh filter on the water side (where applicable)

Pump absorption curves 10.2 - 22.2

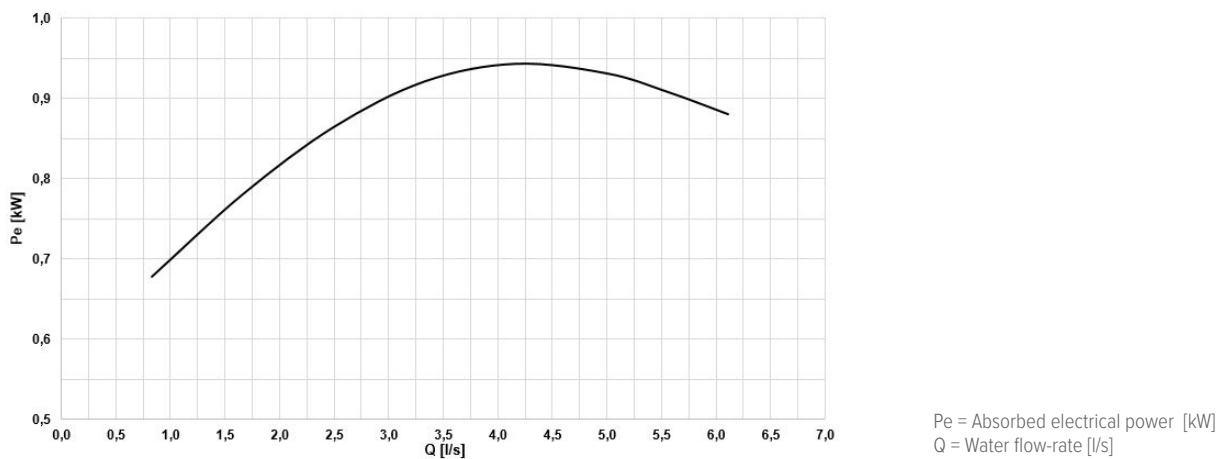

Electrical data

SIZE		10.1	12.1	14.1	16.2	18.2	22.2
F.L.A.	A	1,90	1,90	1,90	1,90	1,90	1,90
F.L.I.	kW	0,75	0,75	0,75	0,75	0,75	0,75

Hydronic assembly

Unit with 1 ON/OFF pump (HYG1)

Pump available pressure curves 30.2 - 35.2 - 40.2

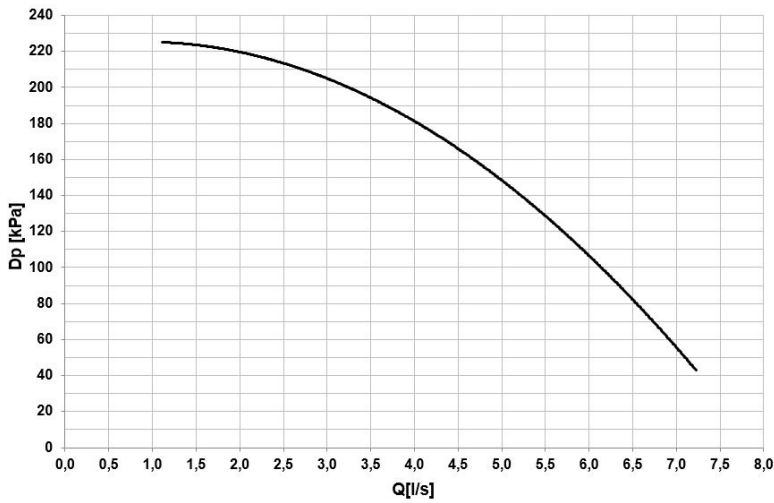

DP = Available pressure [kPa]
Q = Water flow-rate [l/s]

- ⚠ Caution: to obtain the available pressure values, you need to subtract the following from the head values represented in these diagrams:
- User side exchanger pressure drops
 - IFVX accessory –Steel mesh filter on the water side (where applicable)

Pump absorption curves 30.2 - 35.2 - 40.2

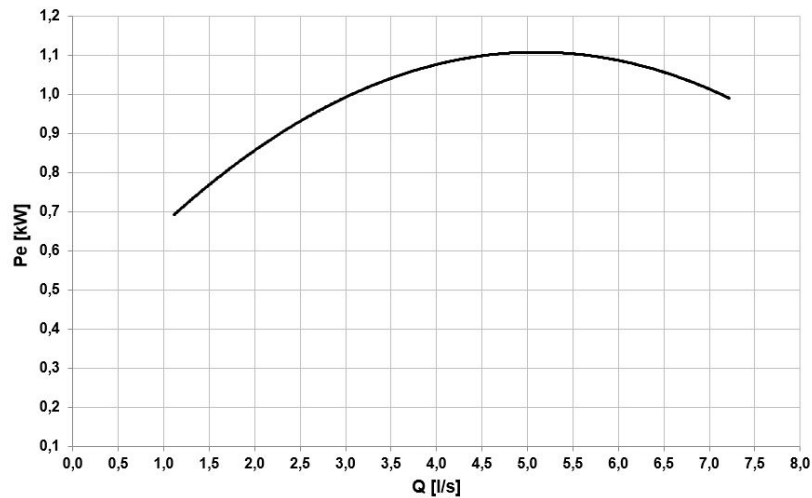

Pe = Absorbed electrical power [kW]
Q = Water flow-rate [l/s]

Electrical data

SIZE		30.2	35.2	40.2
F.L.A.	A	2,5	2,5	2,5
F.L.I.	kW	1,1	1,1	1,1

Unit with 1 inverter pump (HYGU1V)

This configuration provides for one inverter-controlled electric centrifugal pump with body and impeller in AISI 304 steel. The electric pump is equipped with three-phase electric motor with IP55-protection and complete with thermoformed insulated casing. During the installation phase it is possible to choose the most suitable head curve for system requirements by setting the inverter frequency.

The pump will always work at fixed flow.

For the sizes 10.1, 12.1 and 14.1 the water connections are Victaulic type by 1 1/2".

For the sizes 16.2, 18.2, 22.2, 30.2, 35.2 e 40.2 water fittings are Victaulic type by 2".

Pump available pressure curves size 10.1 - 12.1 - 14.1

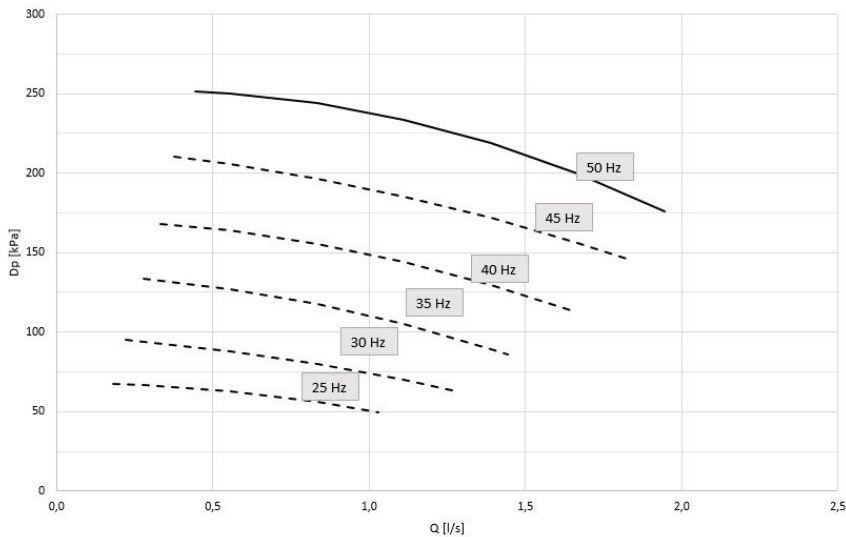

DP = Available pressure [kPa]
Q = Water flow-rate [l/s]

- ⚠ Caution: to obtain the available pressure values, you need to subtract the following from the head values represented in these diagrams:
- User side exchanger pressure drops
 - IFVX accessory – Steel mesh filter on the water side (where applicable)

Pump absorption curves size 10.1 - 12.1 - 14.1

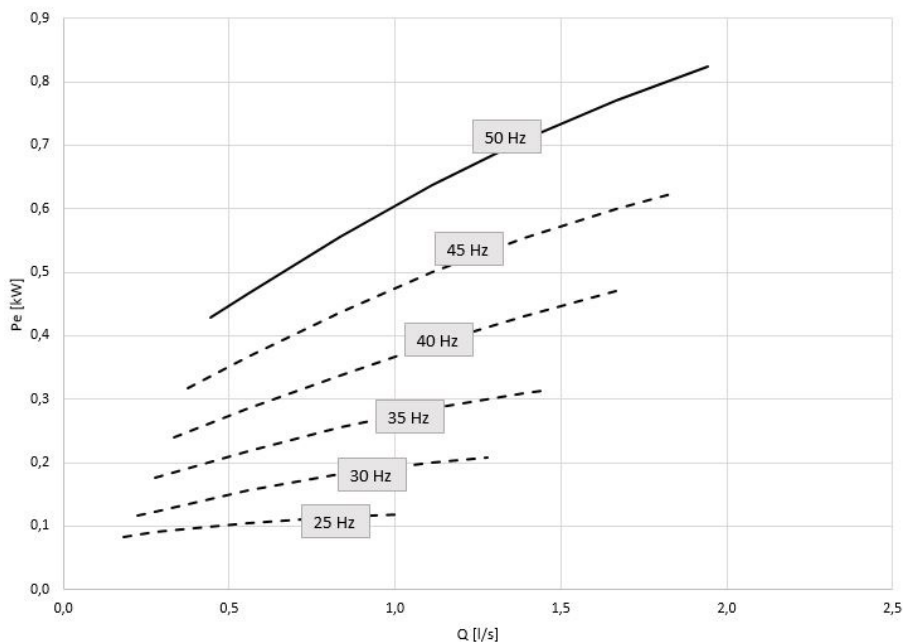

Pe = Power input [kW]
Q = Water flow-rate [l/s]

Hydronic assembly

Unit with 1 inverter pump (HYGU1V)

Pump available pressure curves size 16.2 - 18.2 - 22.2

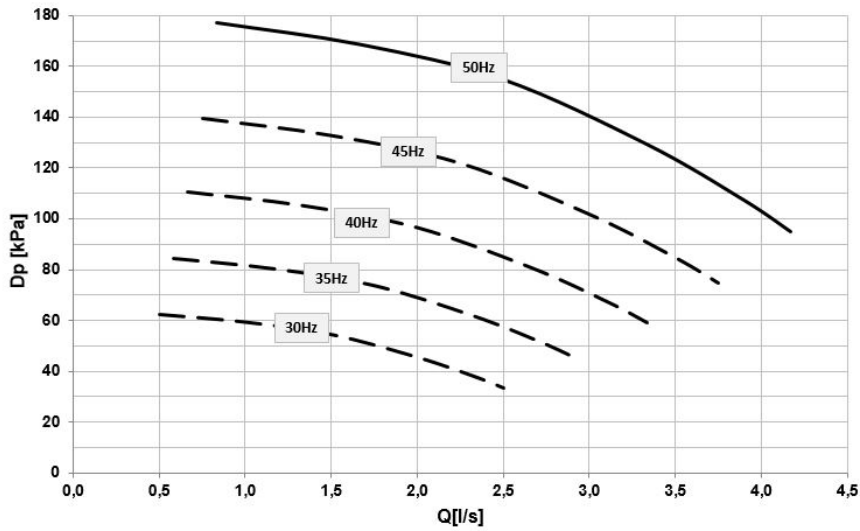

DP = Available pressure [kPa]
Q = Water flow-rate [l/s]

- ⚠ Caution: to obtain the available pressure values, you need to subtract the following from the head values represented in these diagrams:
- User side exchanger pressure drops
 - IFVX accessory –Steel mesh filter on the water side (where applicable)

Pump absorption curves size 16.2 - 18.2 - 22.2

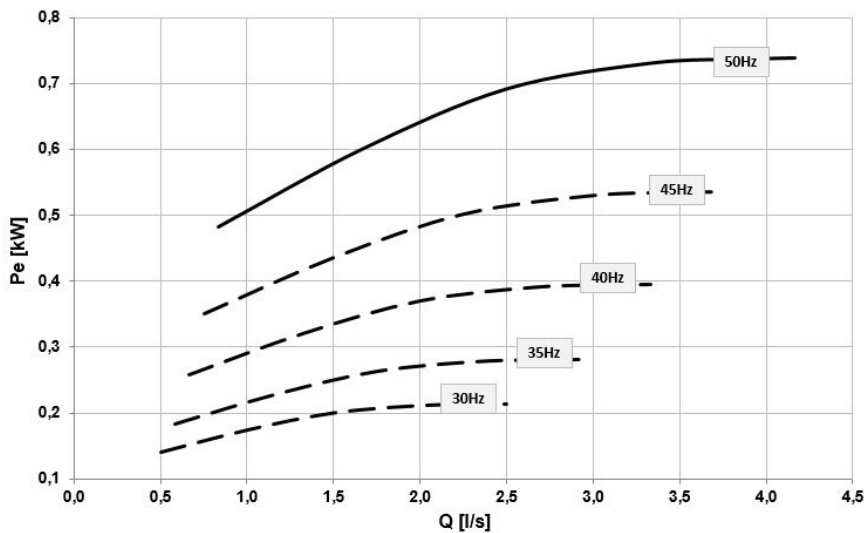

Pe = Power input [kW]
Q = Water flow-rate [l/s]

Electrical data

SIZE		10.1	12.1	14.1	16.2	18.2	22.2
F.L.A.	A	1,90	1,90	1,90	1,90	1,90	1,90
F.L.I.	kW	0,75	0,75	0,75	0,75	0,75	0,75

Unit with 1 inverter pump (HYGU1V)

Pump available pressure curves size 30.2 - 35.2 - 40.2

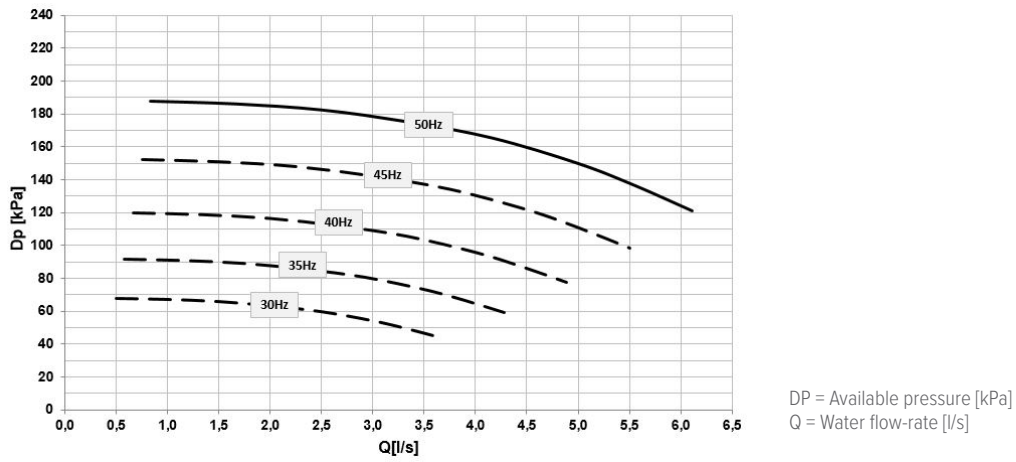

- ⚠ Caution: to obtain the available pressure values, you need to subtract the following from the head values represented in these diagrams:
- User side exchanger pressure drops
 - IFVX accessory – Steel mesh filter on the water side (where applicable)

Pump absorption curves size 30.2 - 35.2 - 40.2

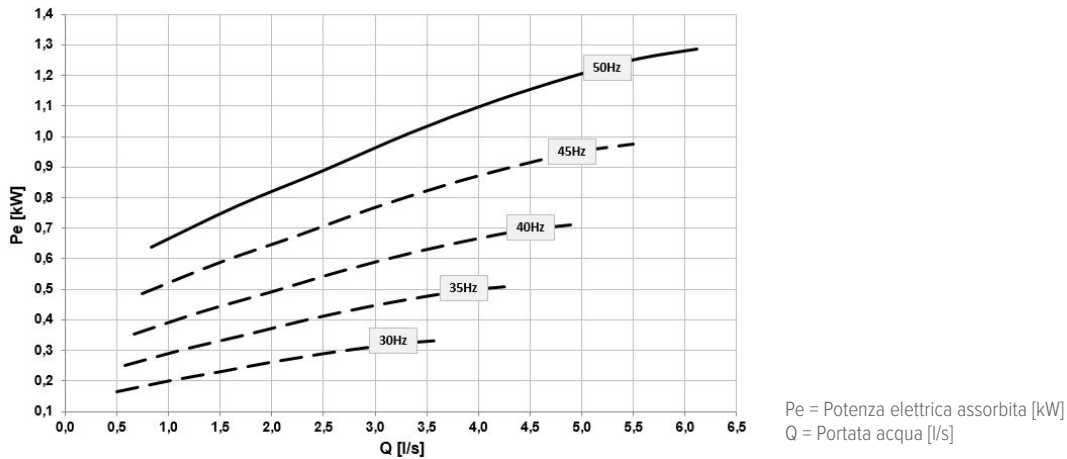

Electrical data

SIZE		30.2	35.2	40.2
F.L.A.	A	2,5	2,5	2,5
F.L.I.	kW	1,1	1,1	1,1

Performances

Heating - Size 10.1

To °C	Tae DB/WB °C	Heating capacity EN14511							COP EN14511						
		Percentage of compressor load							Percentage of compressor load						
		100%	90%	80%	70%	60%	50%	40%	100%	90%	80%	70%	60%	50%	40%
25	-14/-14,3	12,6	11,1	9,72	8,34	6,92	5,52	4,11	2,75	2,72	2,71	2,68	2,65	2,63	2,61
	-7/-8	17,0	15,2	13,6	12,0	10,3	8,66	6,99	3,54	3,55	3,57	3,62	3,64	3,67	3,69
	2/1,1	22,7	20,6	18,5	16,4	14,3	12,2	10,1	4,56	4,63	4,69	4,76	4,83	4,89	4,96
	7/6	26,3	23,9	21,5	19,0	16,6	14,2	11,8	5,23	5,32	5,41	5,49	5,58	5,67	5,76
	10/8,2	28,1	25,5	22,8	20,2	17,5	14,9	12,3	5,59	5,68	5,75	5,85	5,93	6,01	6,10
	18/14	34,6	31,3	28,1	24,9	21,6	18,4	15,1	6,88	7,05	7,20	7,33	7,49	7,64	7,79
30	-14/-14,3	12,2	10,8	9,39	8,07	6,67	5,30	3,92	2,49	2,47	2,44	2,41	2,38	2,35	2,32
	-7/-8	16,6	14,9	13,3	11,8	10,1	8,49	6,87	3,18	3,19	3,22	3,25	3,27	3,29	3,31
	2/1,1	22,3	20,2	18,1	16,0	14,0	11,9	9,80	4,06	4,13	4,18	4,23	4,29	4,34	4,40
	7/6	25,8	23,4	21,0	18,6	16,2	13,8	11,39	4,63	4,71	4,78	4,85	4,92	5,00	5,07
	10/8,2	27,5	24,9	22,3	19,7	17,1	14,5	11,9	4,91	4,98	5,06	5,13	5,21	5,28	5,36
	18/14	33,8	30,6	27,4	24,2	21,0	17,7	14,5	5,97	6,11	6,23	6,33	6,47	6,59	6,71
35	-14/-14,3	11,9	10,5	9,14	7,87	6,49	5,14	3,79	2,27	2,24	2,21	2,17	2,14	2,11	2,08
	-7/-8	16,3	14,7	13,1	11,5	9,93	8,35	6,77	2,88	2,90	2,91	2,92	2,94	2,96	2,97
	2/1,1	21,9	19,8	17,7	15,7	13,6	11,6	9,49	3,65	3,70	3,74	3,77	3,82	3,86	3,90
	7/6	25,3	22,9	20,5	18,1	15,7	13,4	11,0	4,17	4,19	4,25	4,29	4,35	4,41	4,47
	10/8,2	26,9	24,3	21,8	19,3	16,7	14,2	11,6	4,35	4,42	4,48	4,53	4,60	4,67	4,73
	18/14	33,0	29,9	26,7	23,5	20,3	17,1	13,9	5,23	5,35	5,45	5,51	5,62	5,71	5,81
40	-14/-14,3	11,7	10,3	8,96	7,76	6,39	5,09	3,78	2,07	2,04	2,01	1,99	1,95	1,92	1,90
	-7/-8	16,0	14,4	12,9	11,3	9,76	8,20	6,64	2,61	2,63	2,64	2,64	2,65	2,66	2,67
	2/1,1	21,5	19,4	17,4	15,3	13,3	11,2	9,19	3,27	3,31	3,34	3,35	3,39	3,42	3,45
	7/6	24,8	22,4	20,1	17,7	15,3	12,9	10,6	3,66	3,72	3,76	3,78	3,83	3,87	3,91
	10/8,2	26,3	23,8	21,3	18,8	16,3	13,8	11,3	3,84	3,91	3,96	3,98	4,04	4,09	4,14
	18/14	32,2	29,1	25,9	22,7	19,6	16,4	13,3	4,56	4,66	4,74	4,77	4,86	4,93	5,00
45	-14/-14,3	11,4	10,1	8,85	7,71	6,41	5,17	3,93	1,90	1,87	1,84	1,83	1,80	1,78	1,75
	-7/-8	15,8	14,2	12,7	11,2	9,65	8,11	6,58	2,38	2,39	2,39	2,39	2,40	2,41	2,41
	2/1,1	21,1	19,1	17,0	15,0	13,0	10,9	8,91	2,93	2,97	2,99	2,99	3,02	3,04	3,06
	7/6	24,3	21,9	19,6	17,2	14,9	12,5	10,2	3,30	3,31	3,34	3,34	3,38	3,41	3,43
	10/8,2	25,7	23,3	20,8	18,2	15,7	13,2	10,7	3,41	3,47	3,50	3,51	3,55	3,59	3,62
	18/14	31,3	28,2	25,1	21,9	18,8	15,7	12,6	4,00	4,07	4,13	4,15	4,21	4,26	4,31
50	-14/-14,3	-	-	-	-	-	-	-	-	-	-	-	-	-	-
	-7/-8	15,6	14,1	12,6	11,0	9,53	8,01	6,49	2,17	2,18	2,18	2,19	2,20	2,21	2,22
	2/1,1	20,7	18,7	16,7	14,7	12,7	10,7	8,66	2,64	2,67	2,68	2,70	2,72	2,74	2,76
	7/6	23,8	21,4	19,1	16,8	14,5	12,2	9,83	2,91	2,95	2,97	3,00	3,03	3,06	3,08
	10/8,2	25,2	22,7	20,2	17,7	15,3	12,8	10,3	3,03	3,07	3,10	3,13	3,17	3,20	3,23
	18/14	30,5	27,3	24,2	21,1	17,9	14,8	11,7	3,57	3,56	3,59	3,60	3,61	3,62	3,63
54	-14/-14,3	-	-	-	-	-	-	-	-	-	-	-	-	-	-
	-7/-8	-	-	-	-	-	-	-	-	-	-	-	-	-	-
	2/1,1	20,5	18,4	16,5	14,5	12,5	10,5	8,47	2,43	2,45	2,46	2,48	2,49	2,51	2,52
	7/6	23,3	21,1	18,7	16,4	14,1	11,8	9,53	2,66	2,69	2,70	2,73	2,75	2,78	2,80
	10/8,2	24,7	22,2	19,8	17,3	14,8	12,3	9,85	2,77	2,80	2,81	2,83	2,85	2,86	2,88
	18/14	29,8	26,7	23,5	20,3	17,2	14,0	10,8	3,27	3,26	3,22	3,20	3,17	3,15	3,12

To = Leaving internal exchanger water temperature (°C)

Tae [°C]= External exchanger inlet air temperature

Performances in function of the inlet/outlet water temperature differential = 5°C

Heating capacity and COP calculated according to EN 14511:2018

ATTENTION: The data of the heat capacity and COP include defrostings.

Cooling - Size 10.1

To	Tae	Cooling capacity EN14511								EER EN14511							
		Percentage of compressor load								Percentage of compressor load							
		100%	90%	80%	70%	60%	50%	40%	30%	100%	90%	80%	70%	60%	50%	40%	30%
7	15	27,4	25,1	22,9	20,6	18,3	16,0	13,8	11,1	5,55	5,73	5,91	6,09	6,26	6,44	6,62	6,86
	20	26,1	24,0	21,8	19,6	17,5	15,3	13,1	10,6	4,74	4,91	5,07	5,23	5,40	5,56	5,72	5,91
	25	24,9	22,8	20,7	18,7	16,6	14,6	12,5	10,0	4,07	4,21	4,35	4,49	4,63	4,77	4,91	5,05
	30	23,6	21,6	19,7	17,7	15,8	13,8	11,9	9,57	3,51	3,63	3,75	3,87	3,99	4,11	4,23	4,38
	35	22,3	20,4	18,6	16,7	14,9	13,0	11,2	8,96	3,02	3,13	3,23	3,33	3,43	3,54	3,64	3,72
	40	20,9	19,2	17,5	15,7	14,0	12,3	10,5	8,38	2,61	2,69	2,77	2,85	2,94	3,02	3,10	3,17
	44	19,6	18,0	16,4	14,7	13,1	11,5	9,88	7,81	2,25	2,31	2,38	2,45	2,52	2,59	2,66	2,62
10	15	30,1	27,6	25,1	22,6	20,2	17,7	15,2	12,2	6,06	6,27	6,49	6,71	6,92	7,14	7,35	7,62
	20	28,8	26,4	24,0	21,6	19,2	16,9	14,5	11,6	5,16	5,36	5,55	5,74	5,93	6,13	6,32	6,52
	25	27,4	25,1	22,8	20,4	18,1	15,7	13,4	11,0	4,46	4,58	4,70	4,82	4,94	5,06	5,18	5,56
	30	26,0	23,8	21,7	19,5	17,4	15,2	13,1	10,5	3,80	3,94	4,08	4,22	4,36	4,50	4,64	4,78
	35	24,5	22,5	20,5	18,5	16,4	14,4	12,4	9,85	3,27	3,39	3,50	3,62	3,74	3,86	3,98	4,07
	40	23,1	21,2	19,3	17,3	15,4	13,5	11,6	9,21	2,81	2,91	3,01	3,10	3,20	3,29	3,39	3,46
	44	21,6	19,8	18,0	16,2	14,4	12,6	10,8	8,55	2,43	2,50	2,58	2,66	2,73	2,81	2,89	2,84
12	15	32,0	29,3	26,7	24,1	21,4	18,8	16,1	12,9	6,41	6,66	6,92	7,17	7,43	7,68	7,93	8,20
	20	30,5	28,0	25,5	23,0	20,4	17,9	15,4	12,3	5,45	5,67	5,89	6,10	6,32	6,54	6,76	6,98
	25	29,1	26,7	24,2	21,7	19,3	16,8	14,4	11,7	4,68	4,84	5,00	5,15	5,31	5,46	5,62	5,93
	30	27,6	25,3	23,1	20,8	18,5	16,2	14,0	11,1	4,00	4,15	4,31	4,46	4,62	4,77	4,93	5,08
	35	26,1	23,9	21,8	19,6	17,5	15,3	13,1	10,4	3,44	3,56	3,69	3,81	3,94	4,06	4,19	4,32
	40	24,5	22,5	20,5	18,4	16,4	14,3	12,3	9,75	2,96	3,06	3,16	3,27	3,37	3,47	3,58	3,66
	44	23,0	21,1	19,1	17,2	15,3	13,4	11,5	9,05	2,55	2,63	2,72	2,80	2,89	2,98	3,06	3,00
15	15	34,9	32,0	29,1	26,2	23,3	20,4	17,5	13,8	6,96	7,26	7,56	7,86	8,16	8,46	8,76	9,15
	20	33,3	30,5	27,8	25,0	22,3	19,5	16,8	13,3	5,89	6,14	6,40	6,65	6,91	7,16	7,41	7,76
	25	31,8	29,1	26,5	23,9	21,3	18,7	16,1	12,6	5,04	5,27	5,50	5,73	5,96	6,18	6,41	6,58
	30	30,1	27,6	25,1	22,7	20,2	17,7	15,2	12,1	4,31	4,49	4,67	4,85	5,03	5,20	5,38	5,63
	35	28,5	26,1	23,8	21,4	19,0	16,7	14,3	11,4	3,70	3,85	3,99	4,14	4,29	4,44	4,58	4,78
	40	26,8	24,5	22,3	20,1	17,8	15,6	13,4	10,6	3,18	3,30	3,42	3,54	3,66	3,78	3,90	3,99
	44	25,1	23,0	20,9	18,8	16,7	14,6	12,5	9,76	2,73	2,83	2,92	3,02	3,11	3,21	3,30	3,36
18	15	37,8	34,7	31,5	28,4	25,3	22,1	19,0	15,2	7,54	7,89	8,25	8,61	8,96	9,32	9,68	10,06
	20	36,1	33,1	30,1	27,1	24,1	21,1	18,1	14,4	6,36	6,67	6,97	7,28	7,58	7,89	8,19	8,39
	25	34,5	31,6	28,8	25,9	23,0	20,2	17,3	13,8	5,42	5,68	5,93	6,18	6,43	6,69	6,94	7,24
	30	32,7	30,0	27,3	24,5	21,8	19,1	16,4	13,1	4,63	4,83	5,04	5,24	5,45	5,65	5,86	6,13
	35	31,3	29,9	25,7	23,2	20,6	18,0	15,4	12,3	4,12	4,28	4,34	4,46	4,63	4,80	4,96	5,21
	40	29,1	26,6	24,2	21,8	19,3	16,9	14,5	11,4	3,30	3,43	3,56	3,68	3,81	3,94	4,07	4,28
	44	27,2	25,0	22,7	20,4	18,1	15,8	13,5	10,6	2,64	2,73	2,82	2,91	3,00	3,08	3,17	3,36
20	15	39,9	36,5	33,2	29,9	26,6	23,2	19,9	15,7	7,94	8,35	8,76	9,17	9,58	9,99	10,40	10,92
	20	38,1	34,9	31,8	28,6	25,4	22,3	19,1	15,0	6,68	7,02	7,37	7,71	8,05	8,40	8,74	9,08
	25	36,3	33,3	30,3	27,3	24,3	21,3	18,3	14,5	5,69	5,97	6,25	6,53	6,82	7,10	7,38	7,76
	30	34,4	31,6	28,7	25,8	23,0	20,1	17,2	13,7	4,85	5,07	5,30	5,53	5,75	5,98	6,20	6,51
	35	32,5	29,8	27,1	24,4	21,7	19,0	16,3	13,0	4,15	4,33	4,52	4,70	4,88	5,07	5,25	5,50
	40	30,6	28,0	25,5	22,9	20,4	17,8	15,2	12,1	3,56	3,71	3,85	4,00	4,15	4,29	4,44	4,65
	44	28,7	26,3	23,8	21,4	19,0	16,6	14,1	11,4	2,97	3,08	3,19	3,30	3,41	3,52	3,63	3,80

To = Leaving internal exchanger water temperature (°C)

Tae [°C]= External exchanger inlet air temperature

Performances in function of the inlet/outlet water temperature differential = 5°C

Cooling capacity and EER calculated according to EN 14511:2018

Performances

Heating - Size 12.1

To °C	Tae DB/WB °C	Heating capacity EN14511							COP EN14511						
		Percentage of compressor load							Percentage of compressor load						
		100%	90%	80%	70%	60%	50%	40%	100%	90%	80%	70%	60%	50%	40%
25	-14/-14,3	14,5	12,6	11,1	9,44	7,82	6,15	4,52	3,10	3,05	3,01	2,99	2,96	2,92	2,88
	-7/-8	19,1	17,0	15,2	13,3	11,4	9,47	7,55	3,89	3,92	3,93	3,97	4,03	4,10	4,11
	2/1,1	25,3	22,7	20,6	18,1	15,6	13,3	10,9	4,96	5,05	5,13	5,21	5,31	5,39	5,47
	7/6	29,2	26,3	23,9	21,0	18,1	15,4	12,7	5,66	5,79	5,89	6,01	6,12	6,20	6,32
	10/8,2	31,2	28,1	25,5	22,3	19,2	16,3	13,3	6,04	6,18	6,29	6,38	6,50	6,61	6,72
	18/14	38,5	34,6	31,3	27,5	23,6	20,0	16,3	7,39	7,62	7,81	7,99	8,16	8,28	8,50
30	-14/-14,3	14,0	12,2	10,8	9,12	7,57	5,95	4,35	2,81	2,76	2,73	2,69	2,66	2,62	2,58
	-7/-8	18,7	16,6	14,9	13,0	11,1	9,25	7,37	3,51	3,52	3,53	3,57	3,61	3,65	3,66
	2/1,1	24,8	22,3	20,2	17,7	15,2	12,9	10,5	4,42	4,50	4,57	4,64	4,70	4,77	4,84
	7/6	28,7	25,8	23,4	20,5	17,6	15,0	12,2	5,01	5,12	5,21	5,31	5,38	5,43	5,54
	10/8,2	30,6	27,5	24,9	21,8	18,7	15,8	12,9	5,31	5,43	5,52	5,62	5,71	5,76	5,88
	18/14	37,7	33,8	30,6	26,8	22,9	19,3	15,6	6,51	6,61	6,77	6,92	7,06	7,11	7,28
35	-14/-14,3	13,6	11,9	10,5	8,87	7,40	5,81	4,26	2,55	2,51	2,48	2,44	2,40	2,37	2,33
	-7/-8	18,3	16,3	14,7	12,8	10,9	9,09	7,25	3,18	3,19	3,21	3,23	3,25	3,26	3,28
	2/1,1	24,4	21,9	19,8	17,3	14,9	12,6	10,2	3,97	4,04	4,10	4,15	4,19	4,25	4,31
	7/6	28,2	25,3	22,9	20,0	17,2	14,6	11,8	4,25	4,56	4,64	4,71	4,75	4,84	4,92
	10/8,2	30,1	26,9	24,3	21,3	18,2	15,4	12,4	4,71	4,81	4,89	4,97	5,02	5,11	5,19
	18/14	36,8	33,0	29,9	26,0	22,2	18,7	15,1	5,61	5,79	5,93	6,04	6,12	6,28	6,41
40	-14/-14,3	13,3	11,7	10,3	8,71	7,30	5,75	4,24	2,32	2,30	2,26	2,22	2,19	2,16	2,12
	-7/-8	18,0	16,0	14,4	12,6	10,7	8,96	7,16	2,87	2,89	2,91	2,92	2,92	2,92	2,94
	2/1,1	24,0	21,5	19,4	17,0	14,5	12,3	9,92	3,55	3,62	3,66	3,70	3,72	3,77	3,81
	7/6	27,6	24,8	22,4	19,6	16,7	14,1	11,4	3,96	4,05	4,12	4,17	4,19	4,15	4,25
	10/8,2	29,4	26,3	23,8	20,8	17,7	14,9	12,1	4,16	4,25	4,33	4,40	4,40	4,35	4,46
	18/14	36,0	32,2	29,1	25,3	21,4	18,0	14,4	4,94	5,05	5,16	5,26	5,29	5,25	5,39
45	-14/-14,3	13,1	11,4	10,1	8,61	7,32	5,79	4,35	1,97	1,95	1,92	1,89	1,88	1,84	1,82
	-7/-8	17,7	15,8	14,2	12,4	10,6	8,86	7,10	2,42	2,44	2,45	2,46	2,46	2,47	2,48
	2/1,1	23,6	21,1	19,1	16,6	14,2	12,0	9,63	2,96	3,01	3,05	3,07	3,06	3,11	3,14
	7/6	27,1	24,3	21,9	19,1	16,3	13,7	11,0	3,27	3,35	3,40	3,43	3,42	3,49	3,53
	10/8,2	28,7	25,7	23,3	20,3	17,2	14,5	11,6	3,41	3,50	3,56	3,60	3,58	3,66	3,71
	18/14	35,2	31,3	28,2	24,5	20,7	17,2	13,6	4,07	4,11	4,18	4,25	4,25	4,32	4,37
50	-14/-14,3	-	-	-	-	-	-	-	-	-	-	-	-	-	-
	-7/-8	17,5	15,6	14,1	12,3	10,5	8,80	7,06	2,21	2,22	2,23	2,24	2,23	2,25	2,25
	2/1,1	23,2	20,7	18,7	16,3	11,8	10,0	7,30	2,66	2,71	2,74	2,75	2,79	2,82	2,85
	7/6	26,5	23,8	21,4	18,7	15,8	13,3	10,6	2,92	2,98	3,03	3,04	3,02	3,08	3,11
	10/8,2	28,1	25,2	22,7	19,7	16,6	13,9	11,0	3,05	3,11	3,16	3,18	3,14	3,20	3,22
	18/14	34,3	30,5	27,3	23,6	19,9	16,4	12,8	3,64	3,66	3,65	3,69	3,67	3,69	3,70
54	-14/-14,3	-	-	-	-	-	-	-	-	-	-	-	-	-	-
	-7/-8	-	-	-	-	-	-	-	-	-	-	-	-	-	-
	2/1,1	22,8	20,5	18,4	16,2	14,0	11,8	9,60	2,45	2,49	2,52	2,56	2,59	2,63	2,66
	7/6	26,2	23,3	21,1	18,3	15,7	13,1	10,5	2,70	2,73	2,76	2,77	2,80	2,83	2,85
	10/8,2	27,7	24,7	22,2	19,2	16,5	13,7	10,9	2,83	2,85	2,87	2,88	2,90	2,92	2,94
	18/14	32,8	29,3	26,3	22,8	19,5	16,2	12,9	3,23	3,26	3,28	3,29	3,32	3,34	3,36

To = Leaving internal exchanger water temperature (°C)

Tae [°C]= External exchanger inlet air temperature

Performances in function of the inlet/outlet water temperature differential = 5°C

Heating capacity and COP calculated according to EN 14511:2018

ATTENTION: The data of the heat capacity and COP include defrostings.

Cooling - Size 12.1

To	Tae	Cooling capacity EN14511								EER EN14511							
		Percentage of compressor load								Percentage of compressor load							
		100%	90%	80%	70%	60%	50%	40%	30%	100%	90%	80%	70%	60%	50%	40%	30%
°C	°C																
7	15	31,9	29,2	26,1	22,9	20,1	17,1	14,1	11,1	5,18	5,41	5,66	5,92	6,13	6,38	6,62	6,86
	20	30,4	27,9	24,8	21,8	19,2	16,3	13,4	10,6	4,42	4,62	4,84	5,06	5,26	5,48	5,70	5,91
	25	28,9	26,5	23,6	20,7	18,2	15,5	12,7	10,0	3,80	3,97	4,15	4,34	4,51	4,69	4,87	5,05
	30	27,4	25,1	22,4	19,7	17,3	14,7	12,1	9,6	3,26	3,41	3,58	3,75	3,89	4,06	4,22	4,38
	35	25,8	23,7	21,2	18,6	16,3	13,8	11,4	9,0	2,84	2,94	3,08	3,22	3,31	3,46	3,59	3,72
	40	24,2	22,3	19,9	17,4	15,2	13,0	10,7	8,4	2,42	2,53	2,66	2,76	2,83	2,96	3,06	3,17
	44	22,7	20,9	18,6	16,3	14,2	12,1	10,0	7,8	2,09	2,18	2,29	2,37	2,35	2,47	2,54	2,62
10	15	35,0	32,1	28,6	25,1	22,1	18,7	15,5	12,2	5,61	5,88	6,19	6,48	6,75	7,04	7,33	7,62
	20	33,4	30,6	27,3	24,0	21,1	17,9	14,8	11,6	4,77	5,01	5,27	5,54	5,75	6,02	6,27	6,52
	25	31,8	29,2	26,0	22,8	20,0	17,0	14,0	11,0	4,09	4,30	4,52	4,74	4,92	5,14	5,35	5,56
	30	30,1	27,7	24,7	21,6	19,0	16,1	13,3	10,5	3,51	3,69	3,89	4,07	4,22	4,42	4,60	4,78
	35	28,4	26,1	23,3	20,4	17,9	15,2	12,5	9,8	3,02	3,17	3,34	3,49	3,60	3,77	3,92	4,07
	40	26,7	24,6	21,9	19,2	16,8	14,3	11,7	9,2	2,60	2,73	2,87	2,99	3,07	3,22	3,34	3,46
	44	25,0	23,0	20,5	17,9	15,6	13,3	10,9	8,6	2,25	2,35	2,47	2,57	2,54	2,68	2,76	2,84
12	15	37,2	34,1	30,4	26,7	23,5	19,9	16,4	12,9	5,91	6,22	6,56	6,90	7,20	7,54	7,87	8,20
	20	35,5	32,5	29,0	25,5	22,4	19,0	15,7	12,3	5,01	5,28	5,57	5,87	6,12	6,42	6,70	6,98
	25	33,8	31,0	27,7	24,2	21,3	18,1	14,9	11,7	4,29	4,52	4,80	5,01	5,21	5,47	5,70	5,93
	30	32,0	29,4	26,2	23,0	20,2	17,1	14,1	11,1	3,68	3,88	4,09	4,30	4,46	4,68	4,88	5,08
	35	30,2	27,8	24,8	21,7	19,0	16,1	13,3	10,4	3,16	3,33	3,52	3,69	3,80	3,99	4,16	4,32
	40	28,4	26,1	23,3	20,4	17,8	15,1	12,4	9,8	2,73	2,87	3,02	3,15	3,24	3,40	3,53	3,66
	44	26,6	24,5	21,8	19,1	16,6	14,1	11,6	9,0	2,36	2,47	2,60	2,70	2,68	2,82	2,91	3,00
15	15	40,5	37,1	33,1	29,1	25,5	21,5	17,7	13,8	6,36	6,72	7,14	7,56	7,91	8,35	8,75	9,15
	20	38,7	35,5	31,7	27,8	24,4	20,6	16,9	13,3	5,38	5,68	6,05	6,40	6,70	7,07	7,42	7,76
	25	36,8	33,8	30,2	26,4	23,2	19,6	16,1	12,6	4,60	4,87	5,18	5,44	5,68	6,01	6,29	6,58
	30	34,9	32,1	28,6	25,1	22,0	18,6	15,4	12,1	3,94	4,16	4,42	4,66	4,85	5,15	5,39	5,63
	35	33,0	30,3	27,1	23,7	20,7	17,6	14,5	11,4	3,38	3,58	3,78	3,98	4,12	4,38	4,58	4,78
	40	31,0	28,5	25,5	22,2	19,4	16,5	13,5	10,6	2,91	3,07	3,25	3,40	3,51	3,68	3,83	3,99
	44	29,0	26,7	23,8	20,8	18,0	15,3	12,5	9,8	2,52	2,65	2,79	2,91	2,97	3,12	3,24	3,36
18	15	44,0	40,3	36,0	31,5	27,7	23,4	19,3	15,2	6,82	7,25	7,75	8,20	8,67	9,13	9,60	10,06
	20	42,0	38,5	34,4	30,1	26,4	22,3	18,4	14,4	5,79	6,11	6,54	6,90	7,27	7,65	8,02	8,39
	25	40,0	36,7	32,8	28,8	25,1	21,4	17,6	13,8	4,91	5,22	5,58	5,91	6,24	6,57	6,91	7,24
	30	37,9	34,8	31,1	27,2	23,8	20,2	16,6	13,1	4,20	4,46	4,76	5,03	5,30	5,58	5,86	6,13
	35	34,6	32,9	29,4	25,7	22,4	19,1	15,7	12,3	3,94	3,98	4,07	4,29	4,52	4,75	4,98	5,21
	40	33,6	30,9	27,6	24,1	21,0	17,8	14,6	11,4	3,02	3,19	3,38	3,56	3,74	3,92	4,10	4,28
	44	31,5	29,0	25,9	22,6	19,6	16,6	13,6	10,6	2,43	2,56	2,70	2,83	2,96	3,09	3,22	3,36
20	15	46,3	42,5	37,9	33,2	29,1	24,5	20,1	15,7	7,13	7,61	8,18	8,76	9,28	9,83	10,37	10,92
	20	44,3	40,7	36,2	31,7	27,8	23,4	19,2	15,0	6,04	6,51	6,88	7,36	7,78	8,21	8,65	9,08
	25	42,1	38,7	34,5	30,2	26,4	22,5	18,5	14,5	5,13	5,46	5,86	6,26	6,62	7,00	7,38	7,76
	30	39,9	36,7	32,7	28,6	25,0	21,3	17,5	13,7	4,38	4,67	4,99	5,30	5,60	5,90	6,21	6,51
	35	37,7	34,6	30,9	27,0	23,6	20,1	16,5	13,0	3,76	4,00	4,26	4,50	4,75	5,00	5,25	5,50
	40	35,4	32,6	29,1	25,4	22,2	18,9	15,5	12,1	3,24	3,43	3,65	3,84	4,04	4,25	4,45	4,65
	44	33,2	30,5	27,2	23,7	20,9	17,7	14,6	11,4	2,72	2,87	3,03	3,18	3,34	3,49	3,64	3,80

To = Leaving internal exchanger water temperature (°C)

Tae [°C]= External exchanger inlet air temperature

Performances in function of the inlet/outlet water temperature differential = 5°C

Cooling capacity and EER calculated according to EN 14511:2018

Performances

Heating - Size 14.1

To °C	Tae DB/WB °C	Heating capacity EN14511							COP EN14511						
		Percentage of compressor load							Percentage of compressor load						
		100%	90%	80%	70%	60%	50%	40%	100%	90%	80%	70%	60%	50%	40%
25	-14/-14,3	17,2	15,1	12,9	11,1	9,16	7,57	5,37	2,95	2,89	2,83	2,79	2,76	2,75	2,64
	-7/-8	22,1	19,9	17,4	15,2	13,0	11,1	8,67	3,59	3,60	3,63	3,64	3,69	3,74	3,78
	2/1,1	28,8	26,1	23,1	20,6	17,7	15,2	12,3	4,50	4,57	4,67	4,75	4,84	4,93	5,10
	7/6	33,1	30,2	26,8	23,9	20,5	17,6	14,4	5,09	5,21	5,35	5,46	5,59	5,69	5,94
	10/8,2	35,4	32,3	28,6	25,5	21,8	18,7	15,2	5,40	5,55	5,71	5,83	5,93	6,05	6,32
	18/14	43,7	39,8	35,2	31,3	26,8	22,9	18,6	6,58	6,78	7,03	7,24	7,44	7,59	8,05
30	-14/-14,3	16,7	14,6	12,5	10,8	8,85	7,33	5,22	2,66	2,62	2,56	2,53	2,48	2,46	2,37
	-7/-8	21,6	19,4	17,0	14,9	12,7	10,8	8,46	3,23	3,25	3,26	3,28	3,32	3,35	3,39
	2/1,1	28,3	25,7	22,7	20,2	17,3	14,8	12,0	3,99	4,07	4,16	4,24	4,31	4,37	4,54
	7/6	32,5	29,6	26,3	23,4	20,0	17,1	14,0	4,49	4,60	4,73	4,83	4,93	5,00	5,23
	10/8,2	34,8	31,7	28,1	24,9	21,3	18,2	14,8	4,74	4,88	5,02	5,11	5,22	5,30	5,55
	18/14	42,9	39,1	34,5	30,6	26,1	22,2	18,0	5,78	6,02	6,09	6,28	6,44	6,55	6,87
35	-14/-14,3	16,2	14,3	12,2	10,5	8,62	6,70	4,81	2,42	2,38	2,34	2,30	2,25	2,21	2,13
	-7/-8	21,2	19,1	16,6	14,7	12,5	10,2	8,04	2,92	2,94	2,95	2,97	2,99	3,01	3,05
	2/1,1	27,8	25,2	22,3	19,8	16,9	14,3	11,5	3,58	3,65	3,73	3,80	3,85	3,93	4,07
	7/6	32,0	29,1	25,8	22,9	19,6	16,6	13,4	4,16	4,18	4,21	4,30	4,37	4,48	4,67
	10/8,2	34,2	31,1	27,4	24,3	20,8	17,5	14,1	4,20	4,33	4,45	4,53	4,62	4,74	4,95
	18/14	42,0	38,1	33,7	29,9	25,4	21,4	17,2	5,07	5,15	5,35	5,50	5,63	5,78	6,07
40	-14/-14,3	15,7	13,9	12,0	10,3	8,46	7,09	5,10	2,19	2,16	2,13	2,09	2,05	2,03	1,96
	-7/-8	20,8	18,7	16,3	14,4	12,2	10,4	8,20	2,64	2,66	2,68	2,70	2,71	2,71	2,75
	2/1,1	27,3	24,8	21,9	19,4	16,6	14,1	11,4	3,20	3,27	3,34	3,39	3,44	3,44	3,57
	7/6	31,4	28,6	25,3	22,4	19,1	16,3	13,1	3,54	3,64	3,75	3,82	3,87	3,88	4,06
	10/8,2	33,5	30,4	26,8	23,8	20,3	17,2	13,8	3,72	3,83	3,93	4,02	4,08	4,08	4,28
	18/14	41,1	37,3	32,8	29,1	24,6	20,8	16,6	4,49	4,56	4,66	4,79	4,89	4,90	5,12
45	-14/-14,3	15,7	13,9	11,9	10,3	8,53	6,70	4,91	2,00	1,98	1,95	1,92	1,88	1,86	1,80
	-7/-8	20,8	18,7	16,4	14,5	12,3	10,2	8,09	2,39	2,41	2,44	2,45	2,46	2,48	2,52
	2/1,1	27,4	24,8	21,9	19,4	16,5	13,9	11,2	2,87	2,94	3,00	3,05	3,07	3,14	3,24
	7/6	31,4	28,6	25,2	22,4	19,0	16,0	12,9	3,20	3,25	3,34	3,40	3,43	3,52	3,66
	10/8,2	33,5	30,3	26,7	23,7	20,1	16,9	13,6	3,33	3,38	3,49	3,56	3,60	3,69	3,83
	18/14	41,0	37,1	32,6	28,7	24,3	20,2	16,0	4,00	4,06	4,10	4,18	4,25	4,30	4,43
50	-14/-14,3	-	-	-	-	-	-	-	-	-	-	-	-	-	-
	-7/-8	20,5	18,5	16,2	14,3	12,2	10,1	8,08	2,17	2,20	2,22	2,23	2,24	2,26	2,30
	2/1,1	26,9	24,4	21,5	19,1	16,2	13,6	10,9	2,58	2,64	2,70	2,74	2,75	2,81	2,90
	7/6	30,9	28,0	24,7	21,9	18,5	15,5	12,4	2,86	2,90	2,98	3,03	3,04	3,11	3,20
	10/8,2	32,8	29,7	26,1	23,1	19,6	16,4	13,1	3,00	3,04	3,10	3,16	3,18	3,23	3,33
	18/14	40,1	36,2	31,7	27,8	23,4	19,3	15,2	3,58	3,63	3,66	3,65	3,69	3,72	3,77
54	-14/-14,3	-	-	-	-	-	-	-	-	-	-	-	-	-	-
	-7/-8	-	-	-	-	-	-	-	-	-	-	-	-	-	-
	2/1,1	26,6	24,1	21,2	18,8	16,1	13,5	10,9	2,40	2,43	2,49	2,52	2,56	2,60	2,68
	7/6	30,5	27,6	24,2	21,4	18,3	15,3	12,2	2,66	2,69	2,72	2,76	2,79	2,82	2,89
	10/8,2	32,3	29,2	25,7	22,6	19,3	16,1	12,8	2,79	2,82	2,85	2,87	2,90	2,93	2,98
	18/14	38,3	34,7	30,5	26,8	22,9	19,1	15,2	3,18	3,22	3,26	3,28	3,32	3,35	3,42

To = Leaving internal exchanger water temperature (°C)

Tae [°C]= External exchanger inlet air temperature

Performances in function of the inlet/outlet water temperature differential = 5°C

Heating capacity and COP calculated according to EN 14511:2018

ATTENTION: The data of the heat capacity and COP include defrostings.

Cooling - Size 14.1

To	Tae	Cooling capacity EN14511								EER EN14511							
		Percentage of compressor load								Percentage of compressor load							
		100%	90%	80%	70%	60%	50%	40%	30%	100%	90%	80%	70%	60%	50%	40%	30%
°C	°C																
7	15	38,0	35,0	31,0	27,5	23,9	20,4	16,8	13,2	5,24	5,48	5,79	6,05	6,31	6,59	6,86	7,13
	20	36,2	33,4	29,6	26,2	22,8	19,5	16,1	12,7	4,46	4,67	4,95	5,17	5,40	5,65	5,89	6,13
	25	34,4	31,8	28,1	24,9	21,7	18,5	15,3	12,1	3,82	4,01	4,24	4,44	4,64	4,85	5,05	5,26
	30	32,5	30,1	26,7	23,7	20,6	17,6	14,6	11,6	3,28	3,44	3,66	3,83	3,99	4,19	4,37	4,55
	35	29,0	28,4	25,2	22,3	19,4	16,6	13,8	10,9	2,80	2,97	3,15	3,30	3,42	3,59	3,74	3,90
	40	28,7	26,6	23,7	21,0	18,2	15,6	13,0	10,3	2,43	2,56	2,71	2,84	2,94	3,08	3,21	3,34
	44	26,8	24,9	22,2	19,6	17,0	14,6	12,1	9,6	2,10	2,21	2,34	2,44	2,52	2,64	2,75	2,86
10	15	41,7	38,5	34,1	30,2	26,3	22,4	18,5	14,6	5,65	5,94	6,31	6,63	6,93	7,27	7,60	7,92
	20	39,7	36,7	32,5	28,8	25,1	21,4	17,7	14,0	4,79	5,05	5,37	5,66	5,93	6,22	6,51	6,80
	25	37,8	34,9	31,0	27,4	23,9	20,4	16,9	13,4	4,10	4,33	4,64	4,84	5,07	5,33	5,57	5,82
	30	35,7	33,1	29,4	26,1	22,6	19,4	16,1	12,8	3,52	3,71	3,96	4,17	4,35	4,58	4,79	5,00
	35	33,7	31,2	27,8	24,6	21,3	18,3	15,2	12,1	3,03	3,19	3,40	3,57	3,72	3,92	4,09	4,27
	40	31,6	29,3	26,1	23,1	20,0	17,2	14,3	11,3	2,61	2,75	2,93	3,07	3,19	3,35	3,50	3,65
	44	29,6	27,5	24,5	21,6	18,7	16,1	13,3	10,6	2,26	2,37	2,53	2,64	2,73	2,87	2,99	3,11
12	15	44,2	40,8	36,2	32,1	27,9	23,8	19,7	15,5	5,93	6,25	6,68	7,04	7,38	7,77	8,14	8,51
	20	42,2	39,0	34,6	30,6	26,6	22,8	18,8	14,9	5,02	5,30	5,67	5,99	6,29	6,62	6,95	7,27
	25	40,1	37,1	33,0	29,2	25,3	21,7	17,9	14,2	4,30	4,54	4,86	5,10	5,36	5,64	5,91	6,18
	30	38,0	35,2	31,2	27,7	24,0	20,6	17,1	13,6	3,68	3,89	4,17	4,39	4,60	4,85	5,08	5,31
	35	35,8	33,2	29,5	26,2	22,7	19,5	16,1	12,8	3,17	3,34	3,58	3,76	3,93	4,14	4,33	4,53
	40	33,6	31,2	27,8	24,6	21,3	18,3	15,2	12,0	2,73	2,88	3,08	3,23	3,36	3,54	3,70	3,86
	44	31,5	29,2	26,0	23,0	19,9	17,1	14,1	11,2	2,36	2,49	2,65	2,77	2,87	3,02	3,15	3,28
15	15	48,2	44,5	39,5	35,0	30,4	26,1	21,6	17,2	6,35	6,73	7,24	7,67	8,10	8,57	9,02	9,47
	20	46,0	42,5	37,7	33,4	29,0	25,0	20,7	16,4	5,40	5,69	6,13	6,50	6,87	7,24	7,61	7,99
	25	43,7	40,5	35,9	32,0	27,6	24,1	20,1	16,1	4,59	4,87	5,24	5,62	5,83	6,30	6,64	6,99
	30	41,4	38,4	34,1	30,2	26,2	22,8	19,0	15,2	3,93	4,17	4,48	4,74	4,99	5,29	5,57	5,84
	35	39,1	36,2	32,2	28,5	24,7	21,6	18,0	14,4	3,38	3,58	3,85	4,06	4,25	4,52	4,75	4,98
	40	36,7	34,1	30,3	26,8	23,2	19,9	16,5	13,1	2,91	3,08	3,30	3,48	3,63	3,83	4,01	4,19
	44	34,3	31,9	28,4	25,1	21,6	18,6	15,4	12,2	2,52	2,67	2,84	2,99	3,09	3,26	3,41	3,55
18	15	52,3	48,3	42,8	37,9	32,9	28,1	23,2	18,3	6,77	7,22	7,83	8,33	8,86	9,39	9,92	10,45
	20	49,9	46,2	40,9	36,2	31,5	27,1	22,2	17,5	5,74	6,14	6,61	7,02	7,45	7,88	8,31	8,75
	25	47,4	43,9	39,0	34,6	29,9	26,0	21,2	16,8	4,89	5,20	5,64	5,99	6,37	6,74	7,12	7,49
	30	44,9	41,6	37,0	32,8	28,4	24,7	20,2	16,0	4,18	4,45	4,81	5,11	5,42	5,74	6,05	6,36
	35	41,0	38,9	35,0	31,0	26,8	23,4	19,1	15,1	3,60	3,62	4,12	4,37	4,63	4,90	5,16	5,42
	40	39,8	37,0	32,9	29,1	25,1	21,6	17,9	14,2	3,01	3,20	3,43	3,63	3,84	4,05	4,26	4,48
	44	37,3	34,6	30,8	27,3	23,5	20,2	16,7	13,2	2,42	2,57	2,74	2,90	3,05	3,21	3,37	3,53
20	15	55,0	50,9	45,1	39,9	34,7	29,9	24,8	19,6	7,06	7,56	8,23	8,83	9,41	10,01	10,60	11,20
	20	52,5	48,6	43,1	38,2	33,1	28,6	23,7	18,8	5,99	6,40	6,94	7,43	7,90	8,39	8,87	9,36
	25	49,9	46,2	41,1	36,4	31,5	27,4	22,8	18,2	5,09	5,44	5,90	6,32	6,72	7,14	7,55	7,97
	30	47,3	43,8	39,0	34,5	29,9	26,0	21,7	17,4	4,35	4,65	5,03	5,37	5,71	6,05	6,40	6,74
	35	44,6	41,4	36,8	32,6	28,2	24,6	20,6	16,5	3,75	3,99	4,31	4,58	4,86	5,15	5,43	5,71
	40	41,9	38,9	34,6	30,6	27,0	23,2	19,4	15,6	3,23	3,43	3,70	3,92	4,15	4,39	4,62	4,85
	44	39,2	36,5	32,4	28,7	25,8	22,1	18,7	15,2	2,71	2,88	3,09	3,26	3,44	3,63	3,81	4,00

To = Leaving internal exchanger water temperature (°C)

Tae [°C]= External exchanger inlet air temperature

Performances in function of the inlet/outlet water temperature differential = 5°C

Cooling capacity and EER calculated according to EN 14511:2018

Performances

Heating - Size 16.2

To °C	Tae DB/WB °C	Heating capacity EN14511							COP EN14511						
		Percentage of compressor load							Percentage of compressor load						
		100%	90%	80%	70%	60%	50%	40%	100%	90%	80%	70%	60%	50%	40%
25	-14/-14,3	24,4	21,5	18,3	15,3	12,3	9,25	6,22	2,68	2,64	2,60	2,55	2,51	2,46	2,42
	-7/-8	32,4	29,2	25,5	22,6	19,8	16,4	13,2	3,44	3,44	3,45	3,49	3,54	3,54	3,57
	2/1,1	43,3	39,5	34,9	31,1	27,4	23,7	19,3	4,51	4,56	4,61	4,66	4,73	4,82	4,97
	7/6	50,3	45,9	40,7	36,3	31,9	27,6	22,4	5,24	5,31	5,38	5,45	5,52	5,60	5,73
	10/8,2	54,0	49,3	43,6	38,9	34,2	29,5	23,8	5,65	5,72	5,79	5,86	5,93	6,01	6,12
	18/14	66,6	61,0	54,2	48,3	42,3	36,2	28,9	7,11	7,26	7,42	7,51	7,61	7,68	7,80
30	-14/-14,3	23,5	20,8	17,8	15,3	12,3	9,25	6,22	2,43	2,39	2,36	2,32	2,28	2,24	2,21
	-7/-8	31,7	28,5	24,9	22,1	19,3	16,0	12,8	3,11	3,11	3,12	3,15	3,18	3,19	3,21
	2/1,1	42,6	38,7	34,1	30,4	26,7	23,0	18,7	4,04	4,08	4,13	4,17	4,21	4,27	4,33
	7/6	49,4	45,1	39,9	35,5	31,1	26,8	21,6	4,65	4,72	4,79	4,83	4,88	4,92	4,96
	10/8,2	53,1	48,4	42,7	38,0	33,4	28,5	23,0	4,99	5,06	5,12	5,18	5,24	5,24	5,30
	18/14	65,4	59,9	53,0	47,1	41,1	35,0	27,8	6,18	6,32	6,46	6,55	6,60	6,62	6,62
35	-14/-14,3	22,9	20,3	17,4	15,3	12,3	9,25	6,22	2,21	2,18	2,15	2,12	2,08	2,05	2,02
	-7/-8	31,1	27,9	24,4	21,6	18,9	15,6	12,5	2,82	2,82	2,83	2,84	2,86	2,86	2,88
	2/1,1	41,8	38,0	33,5	29,8	26,1	22,4	18,1	3,62	3,66	3,70	3,73	3,75	3,77	3,76
	7/6	48,6	44,3	39,1	34,7	30,4	26,0	20,8	4,01	4,07	4,12	4,16	4,18	4,18	4,15
	10/8,2	52,1	47,4	41,8	37,2	32,4	27,6	22,2	4,42	4,48	4,54	4,58	4,60	4,58	4,57
	18/14	64,2	58,7	51,9	45,9	39,9	33,9	26,6	5,40	5,53	5,65	5,70	5,72	5,71	5,59
40	-14/-14,3	22,4	19,9	18,6	15,6	12,7	9,82	6,91	2,03	2,00	1,97	1,94	1,91	1,88	1,85
	-7/-8	30,5	27,5	24,0	21,3	18,6	15,3	12,3	2,56	2,56	2,57	2,58	2,58	2,59	2,59
	2/1,1	41,2	37,4	32,9	29,2	25,5	21,9	17,4	3,27	3,30	3,33	3,34	3,35	3,38	3,40
	7/6	47,8	43,5	38,3	34,0	29,6	25,3	20,1	3,71	3,76	3,80	3,82	3,82	3,80	3,70
	10/8,2	51,2	46,5	41,0	36,4	31,5	26,9	21,4	3,94	3,99	4,04	4,07	4,05	4,02	3,93
	18/14	63,0	57,5	50,6	44,7	38,7	32,7	25,5	4,77	4,87	4,97	4,99	4,99	4,92	4,75
45	-14/-14,3	22,7	20,3	17,5	15,8	12,7	9,57	6,43	1,86	1,84	1,82	1,79	1,77	1,75	1,73
	-7/-8	31,1	28,0	24,6	21,7	19,0	15,7	12,6	2,34	2,34	2,35	2,34	2,34	2,34	2,59
	2/1,1	41,9	38,0	33,4	29,6	25,8	22,1	17,6	2,94	2,97	2,99	3,00	2,99	2,95	2,86
	7/6	48,6	44,1	38,8	34,3	29,9	25,4	20,0	3,32	3,36	3,39	3,40	3,38	3,33	3,19
	10/8,2	51,9	47,2	41,5	36,6	31,6	27,0	21,3	3,51	3,55	3,60	3,59	3,56	3,52	3,38
	18/14	63,8	58,1	51,0	44,9	38,7	32,5	25,1	4,20	4,28	4,35	4,36	4,33	4,23	4,01
50	-14/-14,3	-	-	-	-	-	-	-	-	-	-	-	-	-	-
	-7/-8	30,7	27,8	24,3	21,5	18,9	15,6	12,6	2,14	2,14	2,14	2,14	2,13	2,13	2,59
	2/1,1	41,3	37,4	32,9	29,1	25,3	21,6	17,1	2,66	2,68	2,70	2,70	2,67	2,62	2,50
	7/6	47,8	43,4	38,0	33,6	29,1	24,7	19,2	2,98	3,01	3,03	3,03	3,00	2,93	2,75
	10/8,2	50,9	46,3	40,5	35,6	30,9	26,2	20,5	3,13	3,17	3,20	3,18	3,15	3,08	2,90
	18/14	62,4	56,6	49,5	43,5	37,4	31,2	23,9	3,70	3,77	3,82	3,81	3,76	3,64	3,38
54	-14/-14,3	-	-	-	-	-	-	-	-	-	-	-	-	-	-
	-7/-8	-	-	-	-	-	-	-	-	-	-	-	-	-	-
	2/1,1	40,8	37,0	32,5	28,7	25,0	21,2	16,7	2,46	2,48	2,49	2,48	2,45	2,38	2,25
	7/6	47,1	42,7	37,4	33,0	28,6	24,1	18,6	2,73	2,76	2,78	2,76	2,72	2,64	2,44
	10/8,2	50,2	45,6	39,7	34,9	30,3	25,6	19,8	2,87	2,90	2,91	2,89	2,86	2,78	2,57
	18/14	61,1	55,4	48,3	42,3	36,3	30,1	22,8	3,35	3,41	3,44	3,43	3,36	3,22	2,95

To = Leaving internal exchanger water temperature (°C)

Tae [°C]= External exchanger inlet air temperature

Performances in function of the inlet/outlet water temperature differential = 5°C

Heating capacity and COP calculated according to EN 14511:2018

ATTENTION: The data of the heat capacity and COP include defrostings.

Cooling - Size 16.2

To	Tae	Cooling capacity EN14511								EER EN14511							
		Percentage of compressor load								Percentage of compressor load							
		100%	90%	80%	70%	60%	50%	40%	30%	100%	90%	80%	70%	60%	50%	40%	30%
7	15	51.2	46.1	41.8	36.8	32.6	27.6	22.8	18.2	5.29	5.44	5.56	5.70	5.83	6.04	6.37	6.42
	20	49.0	44.1	40.0	35.1	31.1	26.2	21.5	17.1	4.52	4.67	4.77	4.91	5.02	5.18	5.41	5.49
	25	46.7	42.0	38.1	33.4	29.5	24.8	20.2	16.0	3.88	4.01	4.11	4.22	4.31	4.42	4.56	4.65
	30	44.4	39.9	36.2	31.6	27.9	23.3	18.9	14.9	3.35	3.45	3.54	3.63	3.69	3.75	3.82	3.91
	35	42.0	37.8	34.2	29.9	26.3	21.9	17.5	13.7	2.69	2.98	3.05	3.12	3.16	3.18	3.17	3.27
	40	39.6	35.6	32.2	28.1	24.6	20.3	16.1	12.5	2.49	2.57	2.62	2.67	2.69	2.67	2.62	2.72
	44	37.2	33.4	30.2	26.3	22.9	18.8	14.6	11.3	2.15	2.21	2.25	2.28	2.28	2.24	2.14	2.23
10	15	56.4	50.8	46.1	40.5	35.8	30.3	24.8	19.8	5.83	6.01	6.15	6.33	6.49	6.71	7.03	7.13
	20	54.0	48.6	44.1	38.6	34.1	28.8	23.4	18.6	4.96	5.13	5.26	5.42	5.55	5.72	5.94	6.06
	25	51.5	46.3	42.0	36.8	32.4	27.2	22.0	17.4	4.24	4.39	4.51	4.64	4.74	4.86	4.98	5.11
	30	49.0	44.1	39.9	34.9	30.7	25.6	20.6	16.2	3.65	3.78	3.87	3.98	4.05	4.11	4.15	4.28
	35	46.4	41.8	37.8	33.0	28.9	24.0	19.1	15.0	3.14	3.25	3.33	3.41	3.46	3.48	3.47	3.59
	40	43.8	39.4	35.6	31.0	27.1	22.3	17.5	13.6	2.70	2.80	2.86	2.92	2.94	2.91	2.83	2.95
	44	41.1	37.0	33.4	29.0	25.2	20.6	15.9	12.2	2.33	2.41	2.45	2.49	2.49	2.43	2.31	2.42
12	15	60.0	54.0	49.0	43.0	38.0	32.1	26.2	20.9	6.20	6.41	6.57	6.77	6.94	7.19	7.55	7.66
	20	57.4	51.7	46.9	41.1	36.3	30.5	24.8	19.7	5.27	5.46	5.61	5.78	5.93	6.11	6.35	6.49
	25	54.8	49.3	44.7	39.1	34.5	28.9	23.3	18.4	4.49	4.66	4.80	4.94	5.05	5.18	5.30	5.45
	30	52.2	47.0	42.6	37.1	32.6	27.2	21.7	17.1	3.86	4.01	4.13	4.22	4.31	4.38	4.40	4.55
	35	49.5	44.5	40.3	35.1	30.7	25.5	20.2	15.7	3.32	3.44	3.53	3.61	3.67	3.69	3.65	3.79
	40	46.7	42.0	37.9	33.0	28.8	23.6	18.5	14.3	2.85	2.95	3.03	3.09	3.11	3.08	2.98	3.12
	44	43.9	39.4	35.6	30.8	26.8	21.8	16.7	12.8	2.46	2.54	2.59	2.63	2.63	2.57	2.42	2.55
15	15	65.6	59.0	53.5	46.9	41.4	34.8	28.3	22.5	6.80	7.05	7.26	7.50	7.71	8.02	8.44	8.58
	20	62.8	56.5	51.2	44.8	39.5	33.1	26.8	21.2	5.74	5.98	6.16	6.37	6.55	6.77	7.05	7.22
	25	60.0	54.0	48.9	42.7	37.6	31.4	25.2	19.8	4.89	5.09	5.24	5.42	5.56	5.70	5.84	6.02
	30	57.1	51.4	46.5	40.6	35.6	29.6	23.5	18.4	4.19	4.36	4.49	4.62	4.71	4.79	4.82	4.99
	35	54.1	48.7	44.0	38.3	33.5	27.7	21.8	16.9	3.59	3.73	3.84	3.94	4.00	4.02	3.97	4.14
	40	51.1	45.9	41.5	36.0	31.4	25.7	20.0	15.4	3.08	3.20	3.28	3.35	3.38	3.35	3.23	3.39
	44	48.0	43.1	38.9	33.6	29.2	23.7	18.1	13.7	2.65	2.75	2.80	2.85	2.85	2.78	2.61	2.76
18	15	71.3	64.2	58.1	50.9	44.9	37.7	31.2	24.5	7.42	7.75	8.00	8.31	8.57	8.94	9.20	9.50
	20	68.3	61.5	55.7	48.7	42.8	35.8	29.6	23.2	6.25	6.54	6.76	7.01	7.23	7.50	7.74	8.00
	25	65.3	58.7	53.2	46.4	40.8	33.9	28.0	21.8	5.31	5.54	5.73	5.94	6.10	6.28	6.49	6.74
	30	62.2	55.9	50.6	44.2	38.6	32.0	26.3	20.3	4.53	4.73	4.89	5.07	5.15	5.24	5.44	5.69
	35	57.7	53.0	47.9	41.6	36.4	29.9	24.5	18.8	3.83	4.04	4.16	4.28	4.35	4.39	4.54	4.84
	40	55.7	50.0	45.1	39.1	34.0	27.8	22.6	17.1	3.32	3.46	3.55	3.63	3.67	3.64	3.77	4.04
	44	52.3	46.9	42.3	36.5	31.6	25.6	20.7	15.4	2.85	2.96	3.03	3.08	3.08	3.01	3.12	3.39
20	15	75.2	67.6	61.3	53.6	47.2	40.0	33.0	26.0	7.87	8.23	8.54	8.90	9.22	9.56	9.90	10.24
	20	72.1	64.9	58.7	51.3	45.1	38.2	31.4	24.7	6.60	6.92	7.18	7.48	7.72	8.02	8.30	8.58
	25	68.8	62.0	56.1	48.9	42.9	36.3	29.8	23.3	5.58	5.86	6.07	6.31	6.49	6.74	6.97	7.19
	30	65.6	59.0	53.4	46.5	40.6	34.3	28.0	21.8	4.76	4.99	5.16	5.35	5.46	5.67	5.85	6.03
	35	62.2	55.9	50.5	43.9	38.3	32.2	26.2	20.2	4.07	4.25	4.39	4.52	4.60	4.77	4.90	5.03
	40	58.7	52.7	47.6	41.2	35.8	30.0	24.3	18.5	3.49	3.64	3.74	3.83	3.87	4.00	4.09	4.19
	44	55.2	49.5	44.6	38.5	33.3	27.7	22.3	16.8	2.99	3.11	3.18	3.24	3.24	3.35	3.41	3.47

To = Leaving internal exchanger water temperature (°C)

Tae [°C]= External exchanger inlet air temperature

Performances in function of the inlet/outlet water temperature differential = 5°C

Cooling capacity and EER calculated according to EN 14511:2018

Performances

Heating - Size 18.2

To °C	Tae DB/WB °C	Heating capacity EN14511							COP EN14511						
		Percentage of compressor load							Percentage of compressor load						
		100%	90%	80%	70%	60%	50%	40%	100%	90%	80%	70%	60%	50%	40%
25	-14/-14,3	29,2	25,2	21,6	18,4	14,6	11,1	7,47	2,76	2,68	2,63	2,59	2,53	2,47	2,42
	-7/-8	37,8	33,5	29,6	25,8	22,2	19,4	15,1	3,45	3,44	3,44	3,46	3,51	3,58	3,56
	2/1,1	49,7	44,8	40,0	35,3	30,6	26,8	22,2	4,46	4,51	4,57	4,62	4,69	4,76	4,89
	7/6	57,5	52,0	46,6	41,1	35,7	31,2	25,8	5,17	5,24	5,32	5,40	5,48	5,56	5,66
	10/8,2	61,7	55,9	50,0	44,1	38,3	33,5	27,5	5,56	5,65	5,74	5,81	5,89	5,97	6,03
	18/14	76,0	68,9	61,9	54,8	47,4	41,2	33,7	6,96	7,11	7,28	7,44	7,55	7,64	7,74
30	-14/-14,3	28,1	24,3	21,0	17,3	13,7	10,1	6,57	2,50	2,43	2,39	2,33	2,27	2,21	2,15
	-7/-8	36,9	32,8	28,9	25,2	21,7	18,9	14,7	3,11	3,11	3,11	3,13	3,16	3,20	3,11
	2/1,1	48,8	44,0	39,2	34,5	29,9	26,1	21,6	3,99	4,04	4,09	4,13	4,18	4,23	4,29
	7/6	56,5	51,1	45,7	40,3	34,9	30,4	25,0	4,57	4,65	4,72	4,80	4,85	4,90	4,94
	10/8,2	60,7	54,9	49,0	43,1	37,4	32,5	26,6	4,90	4,99	5,07	5,14	5,20	5,24	5,27
	18/14	74,4	67,6	60,7	53,6	46,2	40,0	32,5	6,00	6,18	6,34	6,48	6,57	6,61	6,63
35	-14/-14,3	27,2	23,7	20,4	17,0	13,6	10,2	6,79	2,27	2,21	2,17	2,12	2,07	2,02	1,98
	-7/-8	36,1	32,1	28,3	24,7	21,3	18,4	14,4	2,82	2,82	2,82	2,83	2,85	2,87	2,87
	2/1,1	48,0	43,3	38,5	33,8	29,2	25,4	20,9	3,58	3,62	3,67	3,71	3,74	3,76	3,77
	7/6	54,0	50,2	44,9	39,5	34,1	29,6	24,2	4,01	4,14	4,21	4,26	4,30	4,32	4,31
	10/8,2	59,7	53,9	48,0	42,3	36,5	31,5	25,8	4,33	4,42	4,49	4,55	4,60	4,59	4,58
	18/14	73,2	66,4	59,5	52,4	45,0	38,8	31,3	5,24	5,40	5,55	5,66	5,72	5,73	5,67
40	-14/-14,3	26,5	23,1	20,0	16,8	13,6	10,3	7,12	2,07	2,03	1,99	1,95	1,91	1,87	1,83
	-7/-8	35,4	31,5	27,8	24,3	20,9	17,1	13,4	2,56	2,56	2,57	2,57	2,58	2,58	2,58
	2/1,1	47,3	42,6	37,9	33,2	28,6	24,9	20,3	3,22	3,27	3,30	3,33	3,35	3,35	3,31
	7/6	54,8	49,4	44,1	38,7	33,3	28,8	23,5	3,64	3,71	3,77	3,81	3,83	3,82	3,76
	10/8,2	58,7	53,0	47,1	41,4	35,6	30,6	25,0	3,87	3,94	4,00	4,05	4,07	4,04	3,99
	18/14	71,9	65,1	58,3	51,1	43,7	37,6	30,1	4,63	4,77	4,89	4,97	5,00	4,97	4,85
45	-14/-14,3	25,9	22,7	19,8	16,7	13,6	10,6	7,49	1,89	1,86	1,83	1,80	1,77	1,74	1,71
	-7/-8	34,9	31,1	27,5	24,0	20,6	17,9	13,3	2,33	2,34	2,34	2,34	2,34	2,34	2,34
	2/1,1	46,6	41,9	37,3	32,7	28,1	24,3	19,8	2,90	2,94	2,97	2,99	3,00	2,98	2,91
	7/6	54,0	48,6	43,3	37,9	32,6	28,1	22,7	3,26	3,32	3,37	3,39	3,40	3,37	3,27
	10/8,2	57,7	52,0	46,2	40,6	34,6	29,8	24,2	3,44	3,51	3,56	3,60	3,58	3,55	3,47
	18/14	70,5	63,8	56,9	49,8	42,4	36,3	28,8	4,07	4,20	4,30	4,35	4,36	4,30	4,13
50	-14/-14,3	-	-	-	-	-	-	-	-	-	-	-	-	-	-
	-7/-8	34,4	30,7	27,2	23,7	20,4	17,8	13,3	2,13	2,14	2,14	2,14	2,14	2,13	2,13
	2/1,1	45,9	41,3	36,7	32,1	27,6	23,8	19,3	2,62	2,66	2,69	2,70	2,69	2,66	2,57
	7/6	53,1	47,8	42,5	37,2	31,8	27,4	22,0	2,92	2,98	3,02	3,03	3,02	2,97	2,85
	10/8,2	56,7	51,0	45,3	39,6	33,6	29,0	23,4	3,07	3,13	3,18	3,20	3,17	3,13	3,01
	18/14	69,1	62,4	55,5	48,3	41,1	34,9	27,6	3,61	3,70	3,78	3,82	3,80	3,72	3,53
54	-14/-14,3	-	-	-	-	-	-	-	-	-	-	-	-	-	-
	-7/-8	-	-	-	-	-	-	-	-	-	-	-	-	-	-
	2/1,1	45,4	40,8	36,3	31,7	27,2	23,5	19,0	2,42	2,46	2,48	2,49	2,47	2,43	2,33
	7/6	52,4	47,1	41,8	36,6	31,2	26,8	21,4	2,68	2,73	2,77	2,78	2,75	2,70	2,56
	10/8,2	55,8	50,2	44,6	38,7	33,0	28,4	22,7	2,81	2,87	2,91	2,91	2,88	2,83	2,69
	18/14	68,0	61,1	54,3	47,2	39,9	33,8	26,5	3,31	3,35	3,42	3,44	3,41	3,32	3,11

To = Leaving internal exchanger water temperature (°C)

Tae [°C]= External exchanger inlet air temperature

Performances in function of the inlet/outlet water temperature differential = 5°C

Heating capacity and COP calculated according to EN 14511:2018

ATTENTION: The data of the heat capacity and COP include defrostings.

Cooling - Size 18.2

To	Tae	Cooling capacity EN14511								EER EN14511							
		Percentage of compressor load								Percentage of compressor load							
		100%	90%	80%	70%	60%	50%	40%	30%	100%	90%	80%	70%	60%	50%	40%	30%
7	15	58,7	53,4	47,3	42,1	36,9	31,7	25,8	21,0	5,21	5,36	5,54	5,68	5,83	6,01	6,29	6,75
	20	56,1	51,1	45,2	40,2	35,2	30,2	24,5	19,7	4,44	4,58	4,75	4,89	5,02	5,17	5,37	5,70
	25	53,4	48,7	43,1	38,3	33,4	28,6	23,0	18,4	3,80	3,93	4,08	4,20	4,32	4,43	4,55	4,75
	30	50,7	46,3	40,9	36,3	31,7	27,0	21,6	17,1	3,27	3,39	3,52	3,62	3,71	3,78	3,84	3,92
	35	48,0	43,8	38,8	34,4	29,9	25,4	20,2	15,7	2,63	2,92	3,04	3,12	3,19	3,23	3,24	3,21
	40	45,2	41,3	36,5	32,4	28,1	23,8	18,6	14,3	2,43	2,52	2,62	2,68	2,73	2,74	2,70	2,61
	44	42,5	38,8	34,3	30,3	26,2	22,1	17,1	12,9	2,09	2,17	2,25	2,30	2,33	2,32	2,23	2,10
10	15	64,6	58,8	52,1	46,3	40,5	34,8	28,2	22,7	5,71	5,90	6,12	6,30	6,47	6,67	6,97	7,46
	20	61,8	56,3	49,8	44,3	38,7	33,2	26,8	21,4	4,84	5,02	5,22	5,38	5,55	5,71	5,92	6,26
	25	58,9	53,7	47,5	42,2	36,9	31,5	25,2	20,0	4,13	4,29	4,48	4,62	4,75	4,88	5,01	5,18
	30	56,0	51,1	45,2	40,1	34,9	29,7	23,7	18,5	3,55	3,70	3,86	3,97	4,07	4,15	4,21	4,27
	35	53,0	48,4	42,8	38,0	33,0	28,0	22,1	17,0	3,05	3,18	3,31	3,41	3,49	3,53	3,53	3,48
	40	50,0	45,7	40,4	35,8	31,0	26,2	20,4	15,5	2,63	2,74	2,85	2,93	2,98	2,99	2,93	2,82
	44	47,0	42,9	37,9	33,5	28,9	24,3	18,7	13,9	2,27	2,36	2,45	2,51	2,54	2,52	2,42	2,25
12	15	68,6	62,6	55,4	49,2	43,1	36,9	29,9	23,9	6,05	6,28	6,53	6,73	6,94	7,15	7,48	7,98
	20	65,7	59,9	53,0	47,1	41,2	35,2	28,3	22,5	5,12	5,33	5,56	5,74	5,92	6,11	6,34	6,67
	25	62,7	57,2	50,6	44,9	39,2	33,4	26,7	21,1	4,37	4,55	4,75	4,91	5,06	5,19	5,34	5,52
	30	59,7	54,4	48,2	42,7	37,2	31,6	25,1	19,5	3,75	3,91	4,08	4,20	4,32	4,41	4,47	4,52
	35	56,5	51,6	45,6	40,4	35,1	29,7	23,4	18,0	3,22	3,36	3,50	3,61	3,70	3,75	3,74	3,67
	40	53,3	48,7	43,1	38,1	33,0	27,8	21,6	16,3	2,77	2,89	3,01	3,09	3,15	3,17	3,10	2,97
	44	50,1	45,7	40,4	35,7	30,8	25,8	19,8	14,6	2,39	2,49	2,59	2,65	2,68	2,66	2,55	2,36
15	15	75,0	68,3	60,5	53,7	47,0	40,2	32,4	25,8	6,59	6,87	7,18	7,43	7,68	7,96	8,35	8,91
	20	71,8	65,5	58,0	51,4	44,9	38,3	30,7	24,3	5,56	5,81	6,09	6,31	6,53	6,74	7,03	7,37
	25	68,5	62,5	55,3	49,1	42,8	36,4	29,0	22,7	4,73	4,95	5,18	5,37	5,55	5,71	5,87	6,05
	30	65,3	59,6	52,7	46,7	40,6	34,4	27,2	21,1	4,05	4,23	4,44	4,60	4,72	4,83	4,91	4,93
	35	61,9	56,5	49,9	44,2	38,3	32,4	25,4	19,4	3,47	3,63	3,80	3,93	4,03	4,09	4,08	4,01
	40	58,4	53,3	47,1	41,6	36,0	30,3	23,4	17,6	2,99	3,12	3,26	3,36	3,42	3,44	3,37	3,20
	44	54,9	50,1	44,2	39,0	33,6	28,1	21,4	15,7	2,57	2,68	2,80	2,87	2,90	2,89	2,76	2,54
18	15	81,6	74,3	65,8	58,4	51,0	43,5	34,9	27,6	7,16	7,51	7,90	8,21	8,52	8,85	9,36	9,63
	20	78,2	71,2	63,1	55,9	48,7	41,6	33,2	26,8	6,02	6,31	6,66	6,92	7,19	7,45	7,81	8,67
	25	74,7	68,0	60,2	53,4	46,5	39,5	31,3	25,1	5,12	5,36	5,64	5,87	6,08	6,27	6,48	7,04
	30	71,0	64,9	57,4	50,8	44,1	37,3	29,4	23,3	4,36	4,58	4,82	5,01	5,16	5,28	5,37	5,71
	35	66,0	61,5	54,4	48,1	41,6	35,1	27,4	21,4	3,53	3,92	4,12	4,26	4,38	4,45	4,45	4,62
	40	63,6	58,0	51,3	45,3	39,1	32,8	25,3	19,4	3,21	3,36	3,52	3,63	3,71	3,74	3,66	3,70
	44	59,8	54,5	48,1	42,4	36,5	30,4	23,1	17,3	2,76	2,89	3,01	3,10	3,14	3,12	2,99	2,98
20	15	86,2	78,5	69,4	61,6	53,7	45,8	35,1	26,4	7,56	7,95	8,39	8,76	9,13	9,52	9,92	10,30
	20	82,5	75,2	66,5	59,0	51,4	43,7	35,3	28,2	6,34	6,67	7,05	7,37	7,67	7,98	8,61	9,55
	25	78,8	71,9	63,5	56,3	48,9	41,5	33,3	26,3	5,38	5,69	5,97	6,22	6,46	6,68	7,07	7,64
	30	75,0	68,4	60,5	53,6	46,5	39,3	31,4	24,5	4,57	4,81	5,08	5,29	5,49	5,61	5,86	6,18
	35	71,1	64,9	57,3	50,7	43,9	37,0	29,2	22,5	3,91	4,12	4,33	4,50	4,63	4,71	4,83	4,95
	40	67,1	61,3	54,1	47,7	41,2	34,5	26,9	20,4	3,36	3,53	3,70	3,83	3,91	3,94	3,98	3,94
	44	63,1	57,5	50,8	44,7	38,4	31,9	24,6	18,2	2,89	3,03	3,17	3,26	3,30	3,29	3,26	3,16

To = Leaving internal exchanger water temperature (°C)

Tae [°C]= External exchanger inlet air temperature

Performances in function of the inlet/outlet water temperature differential = 5°C

Cooling capacity and EER calculated according to EN 14511:2018

Performances

Heating - Size 22.2

To °C	Tae DB/WB °C	Heating capacity EN14511							COP EN14511						
		Percentage of compressor load							Percentage of compressor load						
		100%	90%	80%	70%	60%	50%	40%	100%	90%	80%	70%	60%	50%	40%
25	-14/-14,3	34,0	29,2	24,9	21,1	16,5	12,2	7,93	2,86	2,76	2,68	2,62	2,53	2,45	2,37
	-7/-8	42,6	37,8	33,2	28,9	24,8	21,1	16,3	3,47	3,45	3,44	3,44	3,46	3,53	3,52
	2/1,1	55,1	49,7	44,4	39,2	34,1	29,1	23,7	4,41	4,46	4,52	4,58	4,64	4,72	4,84
	7/6	63,5	57,5	51,5	45,7	39,8	33,9	27,6	5,09	5,17	5,25	5,33	5,42	5,51	5,62
	10/8,2	67,8	61,7	55,4	49,1	42,6	36,3	29,5	5,44	5,56	5,65	5,75	5,82	5,92	6,01
	18/14	83,9	76,0	68,3	60,8	53,0	44,9	36,2	6,81	6,96	7,13	7,31	7,47	7,59	7,69
30	-14/-14,3	32,6	28,1	24,1	20,4	16,1	12,1	8,00	2,58	2,50	2,43	2,38	2,30	2,23	2,16
	-7/-8	41,5	36,9	32,4	28,2	24,3	20,5	16,0	3,13	3,11	3,11	3,11	3,13	3,17	3,16
	2/1,1	54,1	48,8	43,6	38,4	33,4	28,4	23,1	3,93	3,99	4,04	4,10	4,15	4,21	4,28
	7/6	62,4	56,5	50,7	44,8	38,9	33,1	26,8	4,49	4,57	4,66	4,74	4,81	4,87	4,93
	10/8,2	66,8	60,7	54,4	48,0	41,7	35,4	28,5	4,78	4,90	4,99	5,08	5,15	5,22	5,24
	18/14	82,4	74,4	67,1	59,6	51,8	43,7	35,0	5,86	6,00	6,20	6,37	6,50	6,59	6,63
35	-14/-14,3	31,5	27,2	23,4	19,9	15,9	12,0	8,17	2,34	2,27	2,21	2,17	2,10	2,04	1,99
	-7/-8	40,6	36,1	31,8	27,7	23,8	20,1	15,7	2,82	2,82	2,82	2,82	2,84	2,86	2,85
	2/1,1	53,3	48,0	42,9	37,7	32,7	27,7	22,4	3,52	3,58	3,63	3,67	3,71	3,75	3,77
	7/6	62,0	55,6	49,8	44,0	38,1	32,3	26,0	3,90	4,07	4,15	4,22	4,27	4,31	4,32
	10/8,2	65,7	59,7	53,4	47,1	40,8	34,6	27,6	4,22	4,33	4,43	4,50	4,56	4,61	4,58
	18/14	80,6	73,2	65,8	58,3	50,5	42,5	33,8	5,07	5,24	5,42	5,57	5,68	5,73	5,70
40	-14/-14,3	30,5	26,5	22,9	19,6	15,7	12,1	8,44	2,13	2,07	2,02	1,98	1,93	1,88	1,84
	-7/-8	39,8	35,4	31,2	27,2	23,4	19,7	15,4	2,56	2,56	2,57	2,57	2,57	2,58	2,58
	2/1,1	52,5	47,3	42,2	37,1	32,1	27,1	21,9	3,17	3,22	3,27	3,31	3,34	3,35	3,33
	7/6	60,6	54,8	49,0	43,2	37,4	31,5	25,3	3,56	3,64	3,71	3,77	3,82	3,83	3,79
	10/8,2	64,8	58,7	52,5	46,2	40,0	33,6	26,9	3,76	3,87	3,95	4,01	4,06	4,05	4,01
	18/14	79,1	71,9	64,6	57,1	49,3	41,3	32,6	4,46	4,63	4,78	4,91	4,98	4,99	4,91
45	-14/-14,3	30,8	26,9	23,3	20,1	16,3	12,8	9,17	1,94	1,89	1,86	1,83	1,79	1,75	1,72
	-7/-8	40,6	36,2	31,9	27,9	24,0	20,2	15,9	2,33	2,33	2,34	2,34	2,34	2,34	2,35
	2/1,1	53,7	48,4	43,1	37,9	32,7	27,6	22,1	2,85	2,90	2,95	2,98	3,00	2,99	2,94
	7/6	62,0	56,0	50,0	44,0	38,0	32,0	25,4	3,10	3,18	3,24	3,29	3,31	3,30	3,23
	10/8,2	66,2	59,9	53,4	47,0	40,6	33,9	27,1	3,35	3,44	3,51	3,57	3,60	3,57	3,50
	18/14	80,7	73,2	65,6	57,9	49,8	41,5	32,5	3,95	4,07	4,21	4,31	4,36	4,34	4,20
50	-14/-14,3	-	-	-	-	-	-	-	-	-	-	-	-	-	-
	-7/-8	40,0	35,7	31,6	27,7	23,7	20,1	15,9	2,12	2,13	2,14	2,15	2,14	2,14	2,14
	2/1,1	53,0	47,7	42,5	37,3	32,2	27,1	21,6	2,57	2,62	2,66	2,69	2,70	2,68	2,61
	7/6	61,1	55,1	49,2	43,2	37,2	31,2	24,7	2,85	2,92	2,98	3,02	3,03	3,01	2,90
	10/8,2	65,1	58,9	52,4	46,1	39,5	33,0	26,2	2,99	3,07	3,14	3,19	3,19	3,16	3,06
	18/14	79,3	71,7	64,2	56,4	48,3	40,1	31,1	3,53	3,61	3,71	3,79	3,82	3,78	3,60
54	-14/-14,3	-	-	-	-	-	-	-	-	-	-	-	-	-	-
	-7/-8	-	-	-	-	-	-	-	-	-	-	-	-	-	-
	2/1,1	52,4	47,2	42,0	36,9	31,8	26,7	21,2	2,38	2,42	2,46	2,48	2,48	2,46	2,37
	7/6	60,3	54,4	48,5	42,5	36,6	30,6	24,1	2,62	2,68	2,73	2,77	2,77	2,73	2,61
	10/8,2	64,3	57,9	51,6	45,3	38,7	32,4	25,6	2,74	2,81	2,87	2,91	2,90	2,87	2,75
	18/14	78,2	70,6	62,8	55,1	47,1	38,9	30,0	3,25	3,31	3,35	3,42	3,44	3,38	3,19

To = Leaving internal exchanger water temperature (°C)
 Tae [°C]= External exchanger inlet air temperature
 Performances in function of the inlet/outlet water temperature differential = 5°C
 Heating capacity and COP calculated according to EN 14511:2018
 ATTENTION: The data of the heat capacity and COP include defrostings.

Cooling - Size 22.2

To	Tae	Cooling capacity EN14511								EER EN14511							
		Percentage of compressor load								Percentage of compressor load							
		100%	90%	80%	70%	60%	50%	40%	30%	100%	90%	80%	70%	60%	50%	40%	30%
°C	°C																
7	15	67,6	61,2	54,8	48,4	42,0	35,7	28,7	22,7	5,02	5,21	5,39	5,56	5,74	5,91	6,19	6,66
	20	64,5	58,4	52,3	46,2	40,1	34,0	27,2	21,3	4,25	4,44	4,61	4,77	4,93	5,09	5,30	5,63
	25	61,3	55,6	49,9	44,1	38,2	32,3	25,7	20,0	3,63	3,80	3,96	4,10	4,24	4,37	4,52	4,71
	30	58,2	52,9	47,4	41,9	36,2	30,6	24,1	18,6	3,12	3,27	3,41	3,53	3,65	3,75	3,83	3,91
	35	55,0	50,0	44,9	39,6	34,3	28,9	22,6	17,1	2,64	2,82	2,94	3,05	3,15	3,21	3,24	3,22
	40	51,8	47,1	42,3	37,4	32,3	27,0	21,0	15,7	2,31	2,43	2,54	2,63	2,70	2,74	2,72	2,64
	44	48,5	44,2	39,8	35,1	30,2	25,2	19,3	14,1	1,99	2,09	2,19	2,26	2,32	2,33	2,27	2,13
10	15	74,2	67,3	60,3	53,3	46,2	39,3	31,4	24,6	5,46	5,71	5,93	6,14	6,36	6,56	6,88	7,34
	20	70,9	64,4	57,7	51,0	44,2	37,5	29,8	23,2	4,62	4,84	5,05	5,25	5,44	5,63	5,86	6,19
	25	67,6	61,4	55,0	48,6	42,1	35,6	28,2	21,7	3,94	4,13	4,32	4,50	4,66	4,82	4,97	5,15
	30	64,2	58,4	52,4	46,3	40,0	33,7	26,5	20,2	3,38	3,55	3,72	3,88	4,00	4,11	4,20	4,26
	35	60,7	55,3	49,6	43,8	37,9	31,8	24,8	18,6	2,90	3,05	3,20	3,33	3,44	3,51	3,54	3,49
	40	57,2	52,1	46,8	41,3	35,6	29,8	23,0	17,0	2,50	2,63	2,75	2,86	2,95	2,99	2,96	2,85
	44	53,7	48,9	44,0	38,8	33,4	27,7	21,2	15,3	2,15	2,27	2,37	2,46	2,52	2,54	2,46	2,29
12	15	78,8	71,5	64,1	56,7	49,2	41,7	33,2	26,0	5,77	6,05	6,32	6,57	6,80	7,04	7,39	7,88
	20	75,4	68,5	61,4	54,2	47,0	39,8	31,6	24,5	4,87	5,12	5,36	5,59	5,80	6,01	6,27	6,59
	25	72,0	65,3	58,6	51,8	44,8	37,8	29,8	22,9	4,18	4,37	4,58	4,78	4,96	5,12	5,30	5,47
	30	68,3	62,2	55,8	49,3	42,6	35,8	28,1	21,3	3,55	3,75	3,93	4,11	4,25	4,37	4,46	4,51
	35	64,7	58,9	52,9	46,7	40,3	33,8	26,3	19,7	3,05	3,22	3,38	3,52	3,64	3,73	3,75	3,69
	40	61,0	55,6	49,9	44,0	37,9	31,7	24,4	17,9	2,62	2,77	2,91	3,02	3,12	3,16	3,13	2,99
	44	57,2	52,2	46,9	41,3	35,5	29,5	22,4	16,1	2,26	2,39	2,50	2,60	2,66	2,68	2,60	2,40
15	15	86,2	78,2	70,1	61,9	53,6	45,4	36,1	28,0	6,25	6,59	6,92	7,23	7,52	7,81	8,22	8,79
	20	82,4	74,8	67,2	59,3	51,3	43,4	34,3	26,4	5,26	5,56	5,85	6,13	6,38	6,63	6,93	7,29
	25	78,6	71,4	64,1	56,6	49,0	41,3	32,4	24,7	4,48	4,73	4,98	5,22	5,44	5,63	5,83	6,00
	30	74,7	68,0	61,1	53,9	46,6	39,1	30,5	23,0	3,82	4,05	4,27	4,47	4,67	4,78	4,89	4,91
	35	70,7	64,5	57,9	51,1	44,0	36,9	28,5	21,2	3,28	3,47	3,65	3,82	3,97	4,06	4,09	4,03
	40	66,8	60,9	54,6	48,2	41,4	34,5	26,5	19,3	2,82	2,99	3,14	3,28	3,38	3,44	3,40	3,23
	44	62,7	57,2	51,3	45,2	38,8	32,1	24,3	17,3	2,43	2,57	2,70	2,81	2,88	2,90	2,81	2,58
18	15	93,8	85,1	76,2	67,3	58,3	49,2	39,0	30,7	6,22	6,59	6,96	7,31	7,64	7,99	8,46	8,09
	20	89,7	81,4	73,0	64,5	55,8	47,1	37,1	29,4	5,22	5,54	5,85	6,17	6,46	6,74	7,08	7,48
	25	85,6	77,8	69,8	61,6	53,2	44,8	35,1	27,5	4,43	4,71	4,97	5,23	5,47	5,69	5,92	6,12
	30	81,4	74,0	66,5	58,7	50,6	42,4	33,0	25,6	3,77	4,01	4,25	4,46	4,66	4,81	4,93	4,96
	35	75,6	70,2	63,0	55,6	47,9	40,0	30,9	23,7	3,23	3,44	3,63	3,81	3,96	4,07	4,11	4,02
	40	72,6	66,3	59,5	52,4	45,1	37,5	28,6	21,5	2,78	2,95	3,12	3,26	3,37	3,43	3,40	3,22
	44	68,3	62,3	55,9	49,2	42,2	34,9	26,3	19,3	2,39	2,54	2,67	2,79	2,87	2,89	2,80	2,55
20	15	99,0	89,8	80,4	70,9	61,4	51,8	38,8	27,9	6,53	6,96	7,38	7,78	8,17	8,57	8,46	8,09
	20	94,7	86,0	77,0	68,0	58,8	49,5	39,6	30,9	5,47	5,83	6,19	6,54	6,87	7,19	7,59	8,09
	25	90,3	82,1	73,6	65,0	56,1	47,2	37,4	28,9	4,64	4,95	5,23	5,53	5,80	6,06	6,31	6,55
	30	85,9	78,1	70,1	61,9	53,4	44,7	35,3	27,0	3,95	4,21	4,47	4,71	4,93	5,10	5,24	5,29
	35	81,3	74,0	66,5	58,6	50,5	42,1	33,0	25,0	3,38	3,60	3,82	4,01	4,18	4,30	4,35	4,26
	40	76,7	70,0	62,8	55,3	47,5	39,5	30,6	22,7	2,91	3,09	3,27	3,43	3,55	3,62	3,59	3,40
	44	72,0	65,7	59,0	51,9	44,4	36,7	28,1	20,4	2,50	2,66	2,81	2,93	3,02	3,04	2,95	2,68

To = Leaving internal exchanger water temperature (°C)
 Tae [°C]= External exchanger inlet air temperature
 Performances in function of the inlet/outlet water temperature differential = 5°C
 Cooling capacity and EER calculated according to EN 14511:2018

Performances

Heating - Size 30.2

To °C	Tae DB/WB °C	Heating capacity EN14511							COP EN14511						
		Percentage of compressor load							Percentage of compressor load						
		100%	90%	80%	70%	60%	50%	40%	100%	90%	80%	70%	60%	50%	40%
25	-14/-14,3	41,1	38,2	35,0	31,9	28,4	25,3	22,0	2,71	2,78	2,97	3,07	3,30	3,48	3,79
	-7/-8	52,8	48,8	44,3	40,0	35,2	31,0	26,3	3,50	3,60	3,84	3,98	4,28	4,50	4,82
	2/1,1	69,5	63,9	57,7	51,7	45,0	39,2	32,6	4,55	4,68	5,02	5,19	5,56	5,82	6,12
	7/6	79,3	72,7	65,6	58,7	50,9	44,1	36,4	5,11	5,27	5,66	5,85	6,27	6,55	6,85
	10/8,2	83,4	76,5	68,9	61,6	53,3	46,1	37,9	5,35	5,51	5,93	6,13	6,56	6,85	7,14
	18/14	94,5	87,2	78,7	70,8	61,2	52,8	43,7	5,95	6,20	6,70	7,01	7,55	7,89	8,38
30	-14/-14,3	41,6	38,5	35,0	31,7	28,1	24,9	21,4	2,49	2,56	2,73	2,83	3,03	3,18	3,43
	-7/-8	52,8	48,6	43,9	39,4	34,5	30,2	25,5	3,20	3,29	3,51	3,64	3,89	4,08	4,33
	2/1,1	68,9	63,1	56,8	50,6	43,8	38,0	31,3	4,13	4,26	4,56	4,71	5,04	5,25	5,47
	7/6	78,3	71,7	64,5	57,4	49,5	42,7	34,9	4,62	4,78	5,13	5,31	5,66	5,90	6,12
	10/8,2	82,3	75,3	67,6	60,2	51,8	44,6	36,3	4,84	5,00	5,37	5,55	5,93	6,17	6,38
	18/14	93,3	85,9	77,4	69,3	59,7	51,2	42,0	5,39	5,63	6,08	6,37	6,83	7,13	7,53
35	-14/-14,3	42,3	38,9	35,2	31,6	27,8	24,6	21,0	2,28	2,34	2,48	2,56	2,72	2,84	3,01
	-7/-8	53,0	48,5	43,7	39,0	34,0	29,6	24,7	2,90	2,99	3,17	3,27	3,47	3,61	3,76
	2/1,1	68,4	62,5	56,1	49,8	42,9	37,0	30,2	3,72	3,84	4,09	4,21	4,46	4,61	4,72
	7/6	77,5	70,8	63,5	56,3	48,4	41,5	33,6	4,15	4,30	4,59	4,74	5,01	5,17	5,27
	10/8,2	81,4	74,3	66,6	59,0	50,6	43,4	35,0	4,34	4,49	4,80	4,96	5,24	5,41	5,51
	18/14	92,4	84,9	76,3	68,1	58,5	49,9	40,6	4,85	5,07	5,45	5,70	6,07	6,27	6,52
40	-14/-14,3	43,0	39,4	35,5	31,7	27,7	24,3	20,6	2,08	2,13	2,25	2,30	2,42	2,49	2,59
	-7/-8	53,3	48,6	43,6	38,8	33,6	29,2	24,2	2,63	2,70	2,85	2,92	3,06	3,14	3,20
	2/1,1	68,2	62,1	55,5	49,1	42,2	36,2	29,3	3,35	3,44	3,64	3,74	3,90	3,98	3,99
	7/6	77,0	70,1	62,8	55,5	47,5	40,6	32,6	3,73	3,85	4,09	4,20	4,39	4,47	4,45
	10/8,2	80,8	73,5	65,8	58,1	49,7	42,4	33,9	3,90	4,02	4,27	4,38	4,59	4,67	4,65
	18/14	91,8	84,2	75,5	67,2	57,5	49,0	39,5	4,36	4,55	4,86	5,06	5,33	5,44	5,53
45	-14/-14,3	43,9	40,0	35,8	31,9	27,8	24,2	20,3	1,90	1,94	2,02	2,06	2,13	2,17	2,20
	-7/-8	53,7	48,8	43,7	38,8	33,4	28,9	23,7	2,37	2,43	2,54	2,59	2,68	2,70	2,69
	2/1,1	68,1	61,8	55,2	48,7	41,7	35,7	28,7	3,00	3,07	3,23	3,28	3,39	3,40	3,33
	7/6	73,4	69,7	62,3	54,9	46,9	39,9	31,8	3,19	3,43	3,61	3,68	3,80	3,81	3,71
	10/8,2	80,3	73,0	65,2	57,4	49,0	41,7	33,1	3,47	3,58	3,77	3,85	3,97	3,99	3,88
	18/14	91,4	83,7	74,9	66,6	56,8	48,2	38,7	3,89	4,05	4,30	4,45	4,63	4,66	4,63
50	-14/-14,3	-	-	-	-	-	-	-	-	-	-	-	-	-	-
	-7/-8	54,3	49,2	43,9	38,9	33,4	28,8	23,5	2,14	2,18	2,27	2,29	2,34	2,32	2,26
	2/1,1	68,2	61,8	55,1	48,5	41,4	35,3	28,2	2,68	2,74	2,85	2,88	2,93	2,90	2,78
	7/6	76,6	69,5	62,0	54,5	46,4	39,5	31,3	2,97	3,05	3,19	3,22	3,28	3,25	3,10
	10/8,2	80,2	72,8	64,9	57,0	48,5	41,2	32,7	3,10	3,18	3,32	3,37	3,43	3,40	3,24
	18/14	91,2	83,5	74,6	66,2	56,4	47,8	38,2	3,47	3,60	3,79	3,90	4,01	3,98	3,87
55	-14/-14,3	-	-	-	-	-	-	-	-	-	-	-	-	-	-
	-7/-8	-	-	-	-	-	-	-	-	-	-	-	-	-	-
	2/1,1	68,6	62,1	55,2	48,5	41,3	35,2	28,0	2,40	2,45	2,53	2,53	2,55	2,49	2,33
	7/6	76,7	69,6	62,0	54,4	46,3	39,3	31,1	2,65	2,71	2,81	2,83	2,85	2,78	2,60
	10/8,2	80,2	72,8	64,8	56,9	48,4	41,0	32,5	2,76	2,83	2,93	2,95	2,97	2,90	2,73
	18/14	91,4	83,5	74,7	66,1	56,3	47,7	38,0	3,09	3,20	3,35	3,42	3,47	3,42	3,26

To = Leaving internal exchanger water temperature (°C)

Tae [°C]= External exchanger inlet air temperature

Performances in function of the inlet/outlet water temperature differential = 5°C

Heating capacity and COP calculated according to EN 14511:2018

ATTENTION: The data of the heat capacity and COP include defrostings.

Cooling - Size 30.2

To	Tae	Cooling capacity EN14511								EER EN14511							
		Percentage of compressor load								Percentage of compressor load							
		100%	90%	80%	70%	60%	50%	40%	30%	100%	90%	80%	70%	60%	50%	40%	30%
7	15	80,0	73,6	67,0	59,9	52,4	44,7	36,1	34,9	5,09	5,27	5,71	6,16	6,57	6,90	7,32	5,09
	20	77,2	71,0	64,5	57,6	50,2	42,7	34,1	32,9	4,55	4,74	5,15	5,56	5,94	6,23	6,68	4,55
	25	74,5	68,4	62,1	55,3	48,1	40,6	32,1	30,9	4,03	4,21	4,57	4,92	5,23	5,45	5,83	4,03
	30	71,7	65,9	59,6	52,9	45,9	38,5	30,1	28,9	3,54	3,71	4,00	4,28	4,51	4,64	4,88	3,54
	35	68,9	63,2	57,2	50,7	43,7	36,4	28,1	26,9	3,09	3,23	3,47	3,69	3,83	3,88	3,98	3,09
	40	66,1	60,6	54,7	48,3	41,5	34,4	26,2	25,0	2,69	2,80	2,99	3,14	3,22	3,20	3,18	2,69
	44	63,9	58,5	52,8	46,5	39,8	32,7	24,6	23,4	2,40	2,50	2,65	2,75	2,79	2,72	2,63	2,40
10	15	87,1	80,1	72,8	65,0	56,8	48,3	38,8	37,4	5,44	5,65	6,14	6,62	7,08	7,44	7,90	5,44
	20	84,1	77,3	70,2	62,6	54,5	46,1	36,7	35,3	4,87	5,08	5,53	5,98	6,40	6,71	7,20	4,87
	25	81,2	74,6	67,6	60,1	52,2	43,9	34,6	33,2	4,32	4,52	4,91	5,29	5,63	5,86	6,26	4,32
	30	78,3	71,8	65,1	57,7	49,9	41,7	32,5	31,1	3,80	3,99	4,32	4,62	4,86	5,00	5,26	3,80
	35	75,3	69,1	62,5	55,3	47,6	39,6	30,4	29,1	3,33	3,48	3,75	3,98	4,14	4,19	4,30	3,33
	40	72,4	66,4	59,9	52,9	45,4	37,5	28,4	27,1	2,91	3,03	3,24	3,41	3,49	3,46	3,45	2,91
	44	70,0	64,2	57,9	51,0	43,6	35,8	26,8	25,5	2,60	2,71	2,88	2,99	3,03	2,96	2,87	2,60
12	15	92,1	84,7	76,9	68,6	59,9	50,8	40,7	39,2	5,67	5,91	6,43	6,96	7,45	7,83	8,33	5,67
	20	89,0	81,8	74,2	66,1	57,5	48,5	38,5	37,0	5,08	5,32	5,80	6,28	6,72	7,06	7,58	5,08
	25	85,9	78,9	71,5	63,5	55,1	46,3	36,3	34,9	4,51	4,74	5,16	5,56	5,92	6,17	6,60	4,51
	30	82,9	76,1	68,9	61,1	52,7	44,0	34,2	32,7	3,99	4,18	4,54	4,88	5,12	5,26	5,55	3,99
	35	79,8	73,2	66,2	58,6	50,4	41,9	32,1	30,7	3,50	3,67	3,95	4,20	4,37	4,42	4,54	3,50
	40	76,8	70,4	63,6	56,1	48,1	39,7	30,0	28,6	3,06	3,20	3,42	3,60	3,69	3,66	3,64	3,06
	44	74,4	68,2	61,5	54,2	46,3	38,0	28,4	27,0	2,75	2,86	3,04	3,17	3,21	3,13	3,04	2,75
15	15	99,9	91,9	83,4	74,4	64,8	54,8	43,7	42,1	6,03	6,32	6,91	7,50	8,06	8,81	9,55	6,03
	20	96,7	88,8	80,6	71,7	62,2	52,4	41,4	39,8	5,42	5,70	6,24	6,77	7,27	7,65	8,27	5,42
	25	93,4	85,8	77,7	69,0	59,7	50,1	39,2	37,6	4,83	5,08	5,55	6,01	6,41	6,69	7,19	4,83
	30	90,2	82,8	75,0	66,4	57,3	47,7	36,9	35,3	4,28	4,50	4,90	5,26	5,56	5,71	6,04	4,28
	35	87,1	79,9	72,2	63,8	54,9	45,5	34,8	33,2	3,77	3,96	4,28	4,55	4,74	4,80	4,95	3,77
	40	83,9	77,0	69,5	61,3	52,5	43,3	32,7	31,1	3,31	3,46	3,72	3,91	4,02	3,99	3,99	3,31
	44	81,4	74,7	67,4	59,3	50,7	41,6	31,1	29,5	2,98	3,11	3,31	3,46	3,51	3,43	3,34	2,98
18	15	108,3	99,6	90,4	80,5	70,0	59,1	46,8	45,1	6,43	6,75	7,56	8,30	9,02	9,66	11,79	6,43
	20	104,9	96,4	87,4	77,7	67,4	56,6	44,5	42,8	5,79	6,11	6,71	7,33	7,91	8,37	9,58	5,79
	25	101,5	93,2	84,4	74,9	64,8	54,2	42,2	40,5	5,18	5,46	6,00	6,52	6,98	7,30	7,93	5,18
	30	98,2	90,2	81,6	72,2	62,3	51,8	40,0	38,2	4,59	4,86	5,30	5,72	6,06	6,25	6,65	4,59
	35	95,4	87,1	78,7	69,6	59,8	49,5	37,7	36,0	3,88	4,28	4,65	4,96	5,18	5,26	5,46	3,89
	40	91,7	84,1	76,0	67,0	57,4	47,3	35,6	33,9	3,58	3,77	4,05	4,28	4,41	4,38	4,40	3,58
	44	89,1	81,7	73,8	65,0	55,5	45,6	34,0	32,2	3,24	3,39	3,62	3,79	3,85	3,77	3,69	3,24
20	15	114,3	104,8	95,3	84,8	73,7	62,1	49,2	47,2	6,72	7,17	7,94	8,76	9,58	10,27	12,62	6,72
	20	110,7	101,6	92,2	81,9	71,0	59,6	46,8	44,9	6,06	6,39	7,07	7,75	8,40	8,92	10,27	6,06
	25	107,3	98,5	89,2	79,1	68,3	57,1	44,5	42,6	5,43	5,74	6,33	6,90	7,41	7,80	8,51	5,43
	30	103,8	95,3	86,3	76,4	65,8	54,7	42,1	40,3	4,83	5,11	5,60	6,06	6,44	6,67	7,15	4,83
	35	100,4	92,2	83,4	73,7	63,3	52,4	39,9	38,0	4,07	4,53	4,92	5,27	5,52	5,61	5,86	4,07
	40	97,2	89,2	80,5	71,1	60,9	50,1	37,7	35,9	3,79	3,99	4,30	4,56	4,70	4,68	4,73	3,79
	44	94,6	86,8	78,4	69,0	59,0	48,4	36,1	34,3	3,43	3,60	3,86	4,05	4,12	4,04	3,97	3,43

To = Leaving internal exchanger water temperature (°C)

Tae [°C]= External exchanger inlet air temperature

Performances in function of the inlet/outlet water temperature differential = 5°C

Cooling capacity and EER calculated according to EN 14511:2018

Performances

Heating - Size 35.2

To °C	Tae DB/WB °C	Heating capacity EN14511							COP EN14511						
		Percentage of compressor load							Percentage of compressor load						
		100%	90%	80%	70%	60%	50%	40%	100%	90%	80%	70%	60%	50%	40%
25	-14/-14,3	45,0	41,7	38,7	34,9	31,4	27,3	23,5	2,66	2,71	2,89	3,11	3,30	3,51	3,82
	-7/-8	58,3	53,6	49,4	44,2	39,4	33,7	28,3	3,41	3,50	3,75	4,03	4,29	4,56	4,90
	2/1,1	76,6	70,3	64,8	57,5	50,8	42,9	35,3	4,39	4,53	4,87	5,26	5,61	5,92	6,27
	7/6	87,4	80,0	73,7	65,5	57,7	48,5	39,5	4,92	5,09	5,48	5,93	6,32	6,68	7,03
	10/8,2	92,1	84,3	77,5	68,7	60,5	50,7	41,3	5,15	5,33	5,74	6,20	6,62	6,99	7,34
	18/14	103,4	95,5	88,4	78,5	69,0	57,8	47,5	5,67	5,93	6,45	7,02	7,51	7,97	8,55
30	-14/-14,3	45,9	42,2	39,0	34,9	31,2	26,9	22,9	2,44	2,50	2,67	2,86	3,03	3,22	3,48
	-7/-8	58,5	53,6	49,2	43,8	38,8	33,0	27,4	3,12	3,21	3,43	3,68	3,91	4,14	4,42
	2/1,1	76,1	69,7	64,0	56,5	49,8	41,8	34,0	3,99	4,13	4,43	4,77	5,08	5,36	5,63
	7/6	86,6	79,1	72,6	64,2	56,4	47,1	38,0	4,46	4,62	4,98	5,38	5,72	6,03	6,30
	10/8,2	91,2	83,2	76,3	67,3	59,1	49,3	39,7	4,66	4,84	5,20	5,62	5,99	6,30	6,58
	18/14	102,5	94,3	87,1	77,1	67,6	56,3	45,8	5,13	5,39	5,86	6,37	6,81	7,22	7,71
35	-14/-14,3	46,9	42,9	39,4	35,1	31,2	26,7	22,5	2,24	2,30	2,44	2,60	2,74	2,88	3,07
	-7/-8	59,0	53,8	49,2	43,5	38,4	32,4	26,7	2,84	2,92	3,11	3,32	3,51	3,68	3,87
	2/1,1	75,9	69,2	63,3	55,8	48,9	40,8	32,9	3,60	3,73	4,00	4,28	4,53	4,73	4,89
	7/6	86,0	78,3	71,7	63,2	55,3	46,0	36,8	4,01	4,17	4,48	4,81	5,09	5,32	5,47
	10/8,2	90,4	82,3	75,3	66,2	58,0	48,1	38,4	4,19	4,36	4,67	5,03	5,33	5,56	5,71
	18/14	101,8	93,4	86,1	76,0	66,4	55,1	44,4	4,63	4,86	5,27	5,72	6,07	6,39	6,72
40	-14/-14,3	48,0	43,6	39,9	35,3	31,3	26,6	22,2	2,06	2,11	2,22	2,35	2,46	2,55	2,66
	-7/-8	59,5	54,0	49,2	43,4	38,2	32,0	26,2	2,58	2,66	2,81	2,98	3,12	3,23	3,32
	2/1,1	75,8	68,9	62,9	55,3	48,3	40,1	32,1	3,26	3,37	3,59	3,82	4,00	4,12	4,17
	7/6	85,6	77,8	71,1	62,5	54,5	45,1	35,8	3,62	3,76	4,01	4,28	4,49	4,62	4,66
	10/8,2	90,0	81,7	74,6	65,4	57,1	47,1	37,3	3,78	3,92	4,19	4,47	4,69	4,84	4,87
	18/14	101,3	92,8	85,3	75,2	65,6	54,1	43,3	4,18	4,39	4,73	5,09	5,37	5,58	5,75
45	-14/-14,3	49,3	44,5	40,6	35,7	31,4	26,5	22,0	1,89	1,93	2,02	2,11	2,19	2,24	2,28
	-7/-8	60,3	54,5	49,5	43,4	38,1	31,8	25,8	2,35	2,41	2,53	2,65	2,75	2,80	2,82
	2/1,1	75,9	68,9	62,7	54,9	47,9	39,6	31,5	2,93	3,03	3,20	3,37	3,50	3,55	3,51
	7/6	84,0	77,5	70,7	61,9	53,9	44,4	35,0	3,19	3,37	3,57	3,78	3,92	3,98	3,92
	10/8,2	89,7	81,3	74,0	64,8	56,4	46,4	36,5	3,39	3,51	3,73	3,94	4,10	4,16	4,10
	18/14	101,0	92,4	84,8	74,6	64,9	53,5	42,5	3,75	3,93	4,22	4,50	4,71	4,82	4,86
50	-14/-14,3	-	-	-	-	-	-	-	-	-	-	-	-	-	-
	-7/-8	61,1	55,1	49,9	43,7	38,2	31,8	25,6	2,13	2,18	2,28	2,37	2,42	2,43	2,39
	2/1,1	76,3	69,0	62,7	54,8	47,7	39,3	31,0	2,64	2,72	2,86	2,98	3,06	3,06	2,95
	7/6	85,5	77,4	70,5	61,7	53,6	44,0	34,5	2,92	3,01	3,18	3,33	3,42	3,43	3,30
	10/8,2	89,6	81,1	73,8	64,5	56,0	46,0	36,0	3,04	3,14	3,31	3,47	3,57	3,58	3,45
	18/14	101,0	92,3	84,6	74,3	64,6	53,1	42,0	3,36	3,52	3,75	3,97	4,11	4,15	4,10
54	-14/-14,3	-	-	-	-	-	-	-	-	-	-	-	-	-	-
	-7/-8	-	-	-	-	-	-	-	-	-	-	-	-	-	-
	2/1,1	76,8	69,4	62,9	54,9	47,7	39,2	30,9	2,38	2,45	2,55	2,64	2,68	2,64	2,50
	7/6	85,8	77,6	70,5	61,6	53,5	43,9	34,3	2,62	2,70	2,83	2,94	2,99	2,95	2,79
	10/8,2	89,8	81,2	73,8	64,4	55,9	45,8	35,8	2,72	2,81	2,94	3,06	3,12	3,08	2,92
	18/14	101,3	92,4	84,7	74,3	64,6	53,0	41,9	3,01	3,14	3,33	3,50	3,59	3,58	3,47

To = Leaving internal exchanger water temperature (°C)

Tae [°C]= External exchanger inlet air temperature

Performances in function of the inlet/outlet water temperature differential = 5°C

Heating capacity and COP calculated according to EN 14511:2018

ATTENTION: The data of the heat capacity and COP include defrostings.

Cooling - Size 35.2

To	Tae	Cooling capacity EN14511								EER EN14511							
		Percentage of compressor load								Percentage of compressor load							
		100%	90%	80%	70%	60%	50%	40%	30%	100%	90%	80%	70%	60%	50%	40%	30%
7	15	92,7	85,3	78,4	69,9	60,8	52,4	43,3	33,7	4,74	5,03	5,47	5,93	6,37	6,68	7,18	7,67
	20	89,6	82,4	75,7	67,4	58,5	50,3	41,3	31,8	4,19	4,46	4,87	5,30	5,70	5,98	6,48	7,02
	25	86,3	79,5	73,0	64,9	56,2	48,2	39,3	29,9	3,68	3,94	4,29	4,67	5,01	5,23	5,67	6,11
	30	83,1	76,5	70,3	62,4	53,9	46,0	37,3	28,0	3,23	3,46	3,77	4,08	4,35	4,51	4,83	5,10
	35	79,8	73,6	67,6	59,9	51,6	43,9	35,3	26,1	2,81	3,02	3,28	3,53	3,73	3,82	4,03	4,15
	40	76,6	70,6	64,8	57,4	49,4	41,8	33,3	24,2	2,46	2,63	2,85	3,04	3,18	3,22	3,33	3,29
	44	73,9	68,2	62,6	55,4	47,5	40,1	31,7	22,7	2,21	2,36	2,54	2,70	2,79	2,79	2,83	2,71
10	15	100,8	92,9	85,4	76,0	66,0	56,8	46,8	36,2	5,02	5,35	5,84	6,35	6,84	7,18	7,73	8,27
	20	97,4	89,8	82,5	73,4	63,6	54,5	44,6	34,2	4,44	4,76	5,20	5,67	6,11	6,41	6,98	7,56
	25	94,1	86,6	79,6	70,7	61,2	52,3	42,5	32,1	3,92	4,20	4,60	5,00	5,37	5,62	6,10	6,58
	30	90,7	83,5	76,7	68,1	58,8	50,1	40,4	30,1	3,44	3,70	4,04	4,38	4,68	4,84	5,20	5,50
	35	87,2	80,4	73,8	65,5	56,4	47,8	38,3	28,2	3,02	3,24	3,53	3,80	4,02	4,12	4,36	4,48
	40	83,7	77,2	70,9	62,9	54,0	45,6	36,3	26,2	2,64	2,84	3,07	3,29	3,44	3,48	3,60	3,56
	44	80,9	74,7	68,7	60,8	52,1	43,9	34,7	24,7	2,38	2,55	2,75	2,92	3,03	3,03	3,08	2,95
12	15	106,7	98,0	90,2	80,3	69,7	59,9	49,2	37,9	5,21	5,55	6,08	6,64	7,16	7,53	8,15	9,21
	20	103,1	94,9	87,2	77,6	67,1	57,5	47,0	35,8	4,62	4,95	5,43	5,93	6,40	6,73	7,35	7,97
	25	99,4	91,7	84,2	74,8	64,6	55,2	44,8	33,7	4,07	4,38	4,80	5,24	5,64	5,89	6,42	6,93
	30	96,0	88,4	81,2	72,1	62,2	52,9	42,6	31,7	3,59	3,87	4,23	4,59	4,91	5,08	5,47	5,80
	35	92,4	85,2	78,3	69,4	59,7	50,6	40,5	29,7	3,16	3,40	3,70	4,00	4,23	4,33	4,59	4,72
	40	88,8	81,9	75,3	66,7	57,3	48,4	38,4	27,7	2,77	2,98	3,23	3,46	3,63	3,66	3,80	3,77
	44	85,9	79,4	73,0	64,6	55,4	46,6	36,8	26,1	2,50	2,68	2,89	3,08	3,20	3,20	3,26	3,13
15	15	115,8	106,5	97,8	87,1	75,5	64,8	53,0	40,7	5,50	5,89	6,45	7,08	7,67	8,11	9,17	10,05
	20	112,0	103,1	94,8	84,2	72,8	62,3	50,7	38,5	4,89	5,26	5,78	6,34	6,87	7,24	7,96	8,70
	25	108,2	99,6	91,6	81,3	70,2	59,9	48,5	36,3	4,33	4,67	5,13	5,62	6,06	6,35	6,96	7,56
	30	104,4	96,2	88,5	78,5	67,6	57,5	46,2	34,2	3,83	4,13	4,53	4,94	5,29	5,48	5,94	6,32
	35	100,5	92,9	85,4	75,7	65,1	55,1	44,0	32,1	3,37	3,65	3,98	4,31	4,57	4,69	4,99	5,16
	40	96,8	89,5	82,3	72,9	62,6	52,9	41,9	30,1	2,97	3,21	3,49	3,75	3,93	3,98	4,15	4,13
	44	93,1	86,8	79,8	70,7	60,7	51,1	40,3	28,5	2,64	2,90	3,14	3,35	3,48	3,48	3,57	3,44
18	15	125,6	115,6	106,2	94,4	81,7	70,0	57,2	43,6	5,80	6,24	6,87	7,56	8,26	8,77	10,05	12,47
	20	121,5	111,9	102,8	91,4	79,0	67,4	54,8	41,4	5,17	5,59	6,16	6,79	7,40	7,84	8,71	10,10
	25	117,5	108,3	99,4	88,3	76,2	64,9	52,4	39,2	4,61	4,99	5,49	6,03	6,54	6,88	7,60	8,33
	30	113,5	104,7	96,2	85,4	73,6	62,5	50,2	37,0	4,09	4,43	4,86	5,32	5,72	5,95	6,50	6,96
	35	112,0	101,0	93,0	82,5	71,0	60,1	47,9	34,9	3,41	3,91	4,29	4,66	4,96	5,10	5,47	5,68
	40	105,7	97,6	89,9	79,7	68,4	57,8	45,8	32,8	3,21	3,46	3,78	4,07	4,29	4,34	4,56	4,56
	44	101,6	94,9	87,4	77,4	66,4	55,9	44,1	31,2	2,85	3,14	3,41	3,65	3,80	3,81	3,92	3,80
20	15	132,4	121,9	112,0	99,4	86,1	73,6	60,2	45,7	5,99	6,49	7,16	7,89	8,87	9,51	10,69	13,46
	20	128,2	118,1	108,5	96,4	83,3	71,1	57,7	43,5	5,37	5,83	6,44	7,11	7,79	8,29	9,28	10,87
	25	124,1	114,4	105,1	93,4	80,5	68,5	55,3	41,2	4,81	5,22	5,76	6,36	6,90	7,28	8,11	8,96
	30	120,0	110,7	101,6	90,3	77,8	66,0	53,0	39,0	4,28	4,64	5,10	5,61	6,05	6,31	6,94	7,49
	35	116,0	107,1	98,4	87,3	75,1	63,6	50,7	36,8	3,54	4,12	4,52	4,93	5,26	5,41	5,84	6,11
	40	112,0	103,5	95,3	84,5	72,5	61,2	48,5	34,7	3,38	3,66	4,00	4,32	4,55	4,62	4,87	4,91
	44	107,9	100,6	92,7	82,2	70,5	59,4	46,8	33,2	3,02	3,32	3,61	3,88	4,05	4,06	4,20	4,09

To = Leaving internal exchanger water temperature (°C)

Tae [°C]= External exchanger inlet air temperature

Performances in function of the inlet/outlet water temperature differential = 5°C

Cooling capacity and EER calculated according to EN 14511:2018

Performances

Heating - Size 40.2

To °C	Tae DB/WB °C	Heating capacity EN14511							COP EN14511						
		Percentage of compressor load							Percentage of compressor load						
		100%	90%	80%	70%	60%	50%	40%	100%	90%	80%	70%	60%	50%	40%
25	-14/-14,3	49,1	45,6	42,4	38,3	34,0	29,9	25,8	2,55	2,60	2,76	2,94	3,13	3,28	3,55
	-7/-8	64,2	59,3	54,7	49,0	43,0	37,5	31,7	3,25	3,34	3,56	3,82	4,07	4,28	4,59
	2/1,1	84,7	78,0	72,2	64,4	56,0	48,3	40,2	4,14	4,29	4,63	4,98	5,34	5,60	5,96
	7/6	96,9	89,1	82,3	73,4	63,8	54,9	45,3	4,63	4,82	5,20	5,62	6,03	6,34	6,71
	10/8,2	102,2	94,0	86,7	77,2	66,9	57,6	47,4	4,84	5,05	5,44	5,88	6,31	6,64	7,02
	18/14	114,9	105,6	97,8	87,3	75,8	64,9	54,2	5,33	5,56	6,03	6,56	7,08	7,45	8,05
30	-14/-14,3	50,6	46,7	43,1	38,7	34,0	29,8	25,4	2,33	2,39	2,54	2,70	2,87	3,01	3,24
	-7/-8	65,0	59,7	54,8	48,9	42,6	36,9	31,0	2,95	3,05	3,25	3,48	3,72	3,90	4,17
	2/1,1	84,7	77,7	71,6	63,6	55,1	47,4	39,0	3,74	3,90	4,20	4,52	4,84	5,08	5,38
	7/6	96,4	88,4	81,4	72,3	62,6	53,6	44,0	4,18	4,36	4,70	5,09	5,46	5,74	6,06
	10/8,2	101,5	93,1	85,6	76,0	65,7	56,2	46,0	4,36	4,56	4,92	5,32	5,71	6,01	6,34
	18/14	113,8	104,3	96,7	86,1	74,5	63,6	52,7	4,79	5,01	5,46	5,95	6,42	6,76	7,29
35	-14/-14,3	52,3	47,8	43,9	39,1	34,2	29,7	25,1	2,13	2,19	2,32	2,46	2,61	2,72	2,90
	-7/-8	65,9	60,2	55,1	48,9	42,4	36,6	30,4	2,68	2,78	2,95	3,15	3,35	3,49	3,69
	2/1,1	84,8	77,5	71,2	63,1	54,4	46,6	38,1	3,38	3,52	3,79	4,06	4,33	4,53	4,74
	7/6	96,1	87,9	80,7	71,5	61,7	52,6	42,8	3,75	3,93	4,23	4,56	4,88	5,10	5,33
	10/8,2	101,1	92,4	84,8	75,0	64,6	55,2	44,7	3,92	4,11	4,42	4,77	5,10	5,34	5,57
	18/14	112,9	103,5	95,9	85,1	73,4	62,5	51,4	4,29	4,51	4,91	5,34	5,74	6,02	6,44
40	-14/-14,3	54,0	49,1	44,8	39,7	34,4	29,8	25,0	1,96	2,02	2,12	2,24	2,36	2,43	2,55
	-7/-8	67,0	60,9	55,5	49,0	42,3	36,3	30,0	2,44	2,53	2,68	2,84	2,99	3,10	3,22
	2/1,1	85,0	77,5	70,9	62,7	53,9	46,0	37,3	3,06	3,19	3,41	3,64	3,85	3,99	4,11
	7/6	96,0	87,6	80,3	70,9	61,0	51,9	41,9	3,39	3,55	3,80	4,08	4,33	4,49	4,61
	10/8,2	100,8	92,0	84,2	74,3	63,9	54,3	43,8	3,53	3,70	3,97	4,26	4,52	4,69	4,82
	18/14	112,4	103,1	95,3	84,5	72,7	61,7	50,4	3,87	4,08	4,42	4,78	5,11	5,32	5,60
45	-14/-14,3	55,9	50,5	45,8	40,4	34,8	30,0	24,9	1,81	1,85	1,94	2,03	2,12	2,17	2,23
	-7/-8	68,2	61,7	56,1	49,3	42,4	36,2	29,7	2,23	2,30	2,42	2,55	2,66	2,73	2,78
	2/1,1	85,5	77,7	70,9	62,5	53,6	45,6	36,8	2,76	2,87	3,06	3,24	3,40	3,48	3,52
	7/6	97,3	87,5	80,0	70,5	60,5	51,3	41,2	3,09	3,19	3,40	3,63	3,82	3,91	3,95
	10/8,2	100,7	91,8	83,8	73,8	63,3	53,7	43,0	3,17	3,32	3,55	3,78	3,98	4,09	4,13
	18/14	111,9	102,9	94,9	84,0	72,1	61,1	49,7	3,46	3,66	3,95	4,25	4,51	4,65	4,81
50	-14/-14,3	-	-	-	-	-	-	-	-	-	-	-	-	-	-
	-7/-8	69,5	62,7	56,8	49,7	42,6	36,3	29,6	2,04	2,10	2,20	2,29	2,37	2,40	2,40
	2/1,1	86,2	78,1	71,1	62,6	53,5	45,4	36,5	2,50	2,59	2,74	2,89	3,00	3,04	3,01
	7/6	96,4	87,6	79,9	70,3	60,2	51,0	40,8	2,75	2,87	3,04	3,22	3,36	3,41	3,38
	10/8,2	100,9	91,8	83,7	73,6	63,0	53,3	42,6	2,85	2,98	3,17	3,36	3,50	3,56	3,53
	18/14	112,1	102,9	94,8	83,8	71,9	60,8	49,3	3,11	3,29	3,53	3,78	3,97	4,06	4,13
54	-14/-14,3	-	-	-	-	-	-	-	-	-	-	-	-	-	-
	-7/-8	-	-	-	-	-	-	-	-	-	-	-	-	-	-
	2/1,1	87,0	78,7	71,5	62,8	53,6	45,4	36,4	2,26	2,34	2,46	2,58	2,65	2,66	2,59
	7/6	96,7	88,0	80,1	70,4	60,2	50,9	40,6	2,50	2,58	2,72	2,86	2,96	2,97	2,90
	10/8,2	101,1	92,0	83,8	73,6	62,9	53,2	42,4	2,59	2,68	2,83	2,98	3,08	3,10	3,03
	18/14	112,3	103,2	95,0	83,9	71,9	60,8	49,2	2,82	2,94	3,15	3,36	3,50	3,54	3,55

To = Leaving internal exchanger water temperature (°C)

Tae [°C]= External exchanger inlet air temperature

Performances in function of the inlet/outlet water temperature differential = 5°C

Heating capacity and COP calculated according to EN 14511:2018

ATTENTION: The data of the heat capacity and COP include defrostings.

Cooling - Size 40.2

To	Tae	Cooling capacity EN14511								EER EN14511							
		Percentage of compressor load								Percentage of compressor load							
		100%	90%	80%	70%	60%	50%	40%	30%	100%	90%	80%	70%	60%	50%	40%	30%
°C	°C																
7	15	102,8	95,4	86,5	77,7	68,4	58,6	48,0	38,1	4,50	4,78	5,28	5,72	6,12	6,47	7,02	7,52
	20	99,3	92,2	83,5	75,0	65,9	56,3	45,9	36,1	3,95	4,23	4,68	5,09	5,46	5,77	6,33	6,86
	25	95,9	88,9	80,6	72,3	63,4	54,0	43,7	34,0	3,49	3,72	4,13	4,48	4,80	5,05	5,54	5,98
	30	92,1	85,6	77,6	69,6	60,9	51,7	41,6	32,0	3,04	3,26	3,62	3,92	4,17	4,36	4,73	5,03
	35	88,4	82,3	74,6	66,9	58,4	49,4	39,5	30,0	2,65	2,85	3,15	3,40	3,59	3,72	3,97	4,12
	40	84,7	78,9	71,6	64,1	55,9	47,1	37,3	27,9	2,32	2,49	2,74	2,94	3,08	3,14	3,30	3,31
	44	81,8	76,2	69,2	61,9	53,9	45,3	35,6	26,3	2,08	2,23	2,45	2,61	2,71	2,74	2,82	2,75
10	15	112,0	103,9	94,2	84,6	74,3	63,6	51,9	41,0	4,76	5,07	5,61	6,10	6,55	6,93	7,56	8,10
	20	108,1	100,4	91,0	81,7	71,7	61,1	49,6	38,8	4,19	4,49	4,99	5,44	5,84	6,18	6,81	7,38
	25	104,3	96,9	87,9	78,8	69,0	58,7	47,4	36,7	3,69	3,96	4,41	4,79	5,13	5,41	5,95	6,43
	30	100,4	93,4	84,7	76,0	66,4	56,3	45,1	34,5	3,23	3,48	3,87	4,20	4,48	4,68	5,09	5,42
	35	96,5	89,9	81,5	73,1	63,8	53,9	42,9	32,4	2,83	3,05	3,39	3,65	3,87	3,99	4,29	4,45
	40	92,6	86,3	78,4	70,2	61,2	51,5	40,7	30,3	2,48	2,68	2,95	3,17	3,32	3,39	3,57	3,58
	44	89,4	83,5	75,8	67,9	59,1	49,6	39,0	28,7	2,23	2,40	2,64	2,82	2,94	2,97	3,07	3,00
12	15	118,4	109,9	99,6	89,4	78,5	67,0	54,7	43,0	4,93	5,27	5,84	6,36	6,84	7,25	7,95	8,56
	20	114,3	106,2	96,3	86,4	75,7	64,5	52,3	40,8	4,35	4,67	5,20	5,67	6,11	6,47	7,15	7,77
	25	110,3	102,6	93,0	83,4	73,0	62,0	50,0	38,5	3,83	4,13	4,60	5,01	5,38	5,67	6,26	6,78
	30	106,2	98,9	89,7	80,4	70,3	59,5	47,7	36,3	3,37	3,63	4,05	4,39	4,69	4,90	5,36	5,71
	35	102,1	95,2	86,4	77,5	67,6	57,1	45,4	34,2	2,96	3,20	3,55	3,83	4,06	4,20	4,51	4,69
	40	98,1	91,5	83,2	74,5	64,9	54,7	43,2	32,1	2,60	2,81	3,10	3,33	3,50	3,57	3,77	3,79
	44	94,1	88,6	80,6	72,2	62,8	52,7	41,4	30,4	2,30	2,53	2,78	2,97	3,10	3,13	3,24	3,18
15	15	128,5	119,3	108,1	97,0	85,1	72,6	59,0	46,2	5,18	5,56	6,19	6,76	7,30	7,78	8,60	9,76
	20	124,2	115,4	104,5	93,8	82,2	69,9	56,5	43,9	4,59	4,95	5,53	6,04	6,53	6,94	7,73	8,46
	25	119,9	111,5	101,2	90,7	79,3	67,3	54,1	41,6	4,06	4,39	4,91	5,35	5,76	6,09	6,76	7,37
	30	115,6	107,6	97,6	87,6	76,5	64,7	51,7	39,3	3,58	3,88	4,33	4,71	5,04	5,28	5,81	6,21
	35	111,3	103,7	94,2	84,5	73,7	62,2	49,4	37,1	3,16	3,42	3,81	4,12	4,37	4,53	4,90	5,12
	40	106,9	99,9	90,8	81,4	71,0	59,7	47,1	34,9	2,79	3,01	3,34	3,60	3,78	3,87	4,10	4,14
	44	102,6	96,9	88,1	79,0	68,8	57,8	45,3	33,3	2,47	2,72	3,01	3,22	3,36	3,40	3,54	3,48
18	15	139,2	129,3	117,2	105,1	92,2	78,5	63,6	49,6	5,42	5,87	6,57	7,19	7,81	8,38	9,70	11,91
	20	134,7	125,2	113,5	101,8	89,1	75,7	61,1	47,2	4,84	5,25	5,88	6,44	6,99	7,48	8,43	9,74
	25	130,1	121,1	109,9	98,6	86,1	73,0	58,6	44,9	4,30	4,67	5,24	5,74	6,19	6,57	7,37	8,10
	30	125,7	117,0	106,2	95,3	83,2	70,3	56,1	42,5	3,82	4,14	4,64	5,06	5,43	5,71	6,33	6,82
	35	119,0	113,0	102,7	92,1	80,3	67,7	53,7	40,2	3,29	3,67	4,10	4,45	4,73	4,91	5,35	5,63
	40	116,7	109,0	99,2	88,9	77,5	65,2	51,4	38,1	3,00	3,25	3,61	3,90	4,11	4,21	4,49	4,57
	44	112,2	105,0	96,4	86,4	75,3	63,2	49,6	36,4	2,67	2,89	3,26	3,50	3,66	3,71	3,89	3,85
20	15	146,7	136,4	123,7	110,8	97,1	82,5	66,9	52,0	5,59	6,07	6,84	7,51	8,17	9,00	10,30	12,89
	20	142,1	132,1	119,8	107,4	94,0	79,8	64,4	49,6	5,01	5,45	6,14	6,74	7,33	7,88	8,95	10,48
	25	137,4	127,9	116,1	104,0	91,0	77,1	61,8	47,2	4,47	4,87	5,48	6,01	6,51	6,95	7,84	8,69
	30	132,8	123,8	112,3	100,7	88,0	74,3	59,3	44,8	3,99	4,34	4,87	5,31	5,72	6,03	6,73	7,31
	35	128,2	119,6	108,7	97,5	85,1	71,7	56,9	42,5	3,51	3,86	4,31	4,68	5,00	5,20	5,70	6,03
	40	123,6	115,5	105,1	94,3	82,2	69,2	54,5	40,3	3,16	3,43	3,81	4,12	4,35	4,47	4,79	4,90
	44	119,0	111,4	102,3	91,7	80,0	67,2	52,7	38,6	2,82	3,06	3,45	3,71	3,89	3,95	4,16	4,13

To = Leaving internal exchanger water temperature (°C)

Tae [°C]= External exchanger inlet air temperature

Performances in function of the inlet/outlet water temperature differential = 5°C

Cooling capacity and EER calculated according to EN 14511:2018

System configurations

Management of auxiliary heat source

In heating mode, ELFOEnergy Sheen EVO is able to manage (on/off) an auxiliary heating source (eg. a traditional gas boiler), in integration to the heat pump. Control signal is given through terminals CN19_L and CN19_N, while power supply of auxiliary heater must be independent.

Activation of this auxiliary heater is related to outdoor air temperature and supply water temperature, as follow:

- **Outdoor air temperature.** Auxiliary heater can be activated when outdoor air temperature is $< 13^{\circ}\text{C}$. Once in operation, it is deactivated when outdoor air temperature is $\geq 15^{\circ}\text{C}$
- **Supply water temperature.** Values set by default require auxiliary heater to be activated when leaving water temperature is $< 25^{\circ}\text{C}$, while it is deactivated when it reaches a value $\geq 45^{\circ}\text{C}$. These values can be set directly on user interface. Auxiliary heater activation/deactivation temperature cannot be higher of the set-point one.

Modularity

Thanks to this functionality, already activated on all ELFOEnergy Sheen EVO units without any additional accessory, it is possible to operate with up to 16 units connected in hydraulic parallel.

All the slave units are wired together in series, through dedicated terminals P, Q and E on respective main board, and to the Master unit user interface.

Each connected module is identified with an address, from 0 to 15: Master unit is identified as 0. The system is completely managed by the Master unit (including auxiliary components such as auxiliary heater and external pumping group).

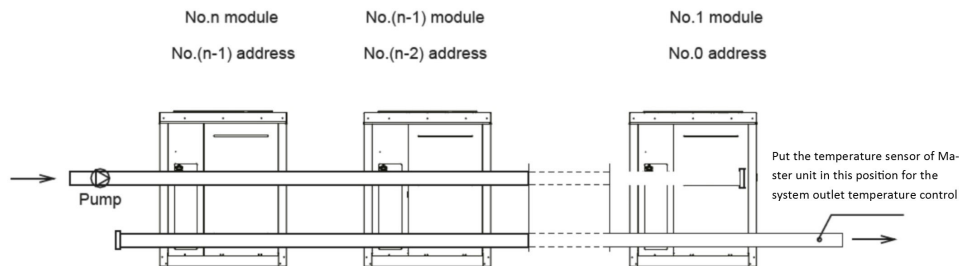

Operation

Master unit calculates the modular combination heating/cooling, based on supply water temperature and set-point temperature. Each single unit calculates the capacity output based on its own water outlet and inlet temperature. Activation of Slave follows the logic of first in first out (the first unit to be activated will be also the first to be deactivated) and it is indicated in the charts below:

T_w = Supply water temperature

T_{ws} = Set-point of Supply water temperature

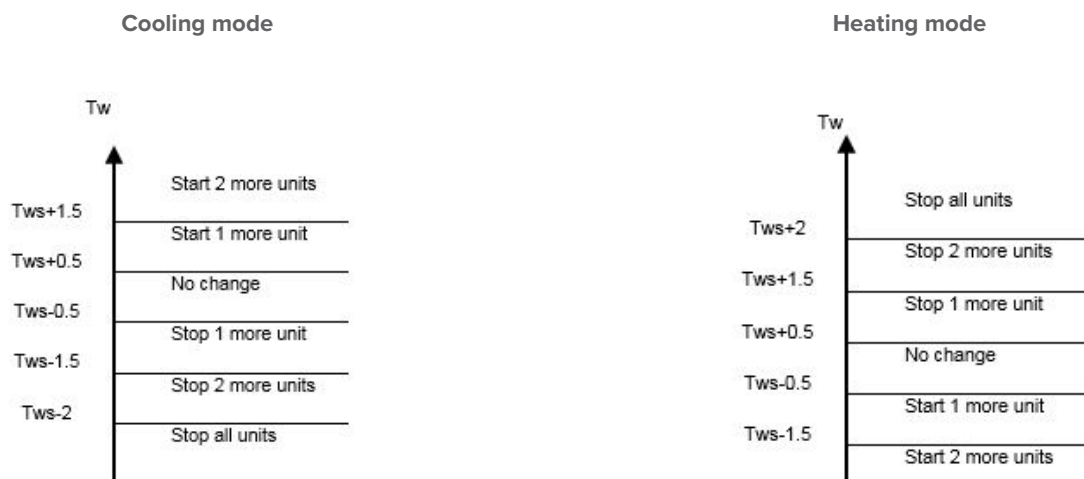

In cooling mode, if $T_w \geq T_{ws} - 10^{\circ}\text{C}$ 50% of units are activated.

In the same way, in heating mode, if $T_w \leq T_{ws} - 10^{\circ}\text{C}$ 50% of units are activated.

Operation during a fault or in “protection” mode

When Master unit or a Slave unit is in “protection” mode (unit is in stand-by while hydraulic pump continues to run, except the case when there is no water flow), only the unit in “protection” stops while all the other units continue to operate.

On the other hand, if Master unit fails and then stops, also all the Slave units of the system stop to operate. If a Slave unit fails, all the other units continue to operate.

Protection mode occurs during one of the following conditions:

- System high pressure or exhaust temperature protection is activated
- System low voltage protection is activated
- Compressor current protection is activated
- Frequency protection of inverter compressor in cooling mode and heating mode is activated
- Condenser high temperature protection is activated
- High temperature difference between inlet water and outlet water protection is activated
- Anti-freezing protection is activated
- Discharge temperature sensor malfunction
- Evaporator low temperature protection is activated (invalid when in standby state)
- Frequency protection is activated
- Inverter compressor malfunction
- DC fan motor protection is activated
- High return water temperature protection in cooling mode is activated
- Low pressure anti-freezing protection is activated
- High temperature of inverter compressor module

Domestic hot water management in the modular system

Every module of the system can produce domestic hot water.

- It is necessary for each module dedicated to producing DHW to be equipped with 3-way valve installed on board (3DHW).
- Every module must have its own circulation pump and its own domestic hot water storage (responsibility of the Customer).
- The DHW pumping unit will be managed directly by the unit dedicated to DHW using a free contact.
- DHW production only takes place if the DHW storage temperature is above a minimum threshold. The minimum temperature threshold varies based on the external temperature. In order to avoid that it falls under the minimum temperature, it is best to install a backup electric heater on the DHW storage.

t outdoor	t5 (DHW storage)	compr.	backup heater
$24^{\circ}\text{C} < t.o \leq 30^{\circ}\text{C}$	$< 15^{\circ}\text{C}$	OFF	ON
$24^{\circ}\text{C} < t.o \leq 30^{\circ}\text{C}$	$\geq 15^{\circ}\text{C}$	ON	OFF
$t.o > 30^{\circ}\text{C}$	$< 20^{\circ}\text{C}$	OFF	ON
$t.o > 30^{\circ}\text{C}$	$\geq 20^{\circ}\text{C}$	ON	OFF

Domestic hot water management is of priority compared to the system.

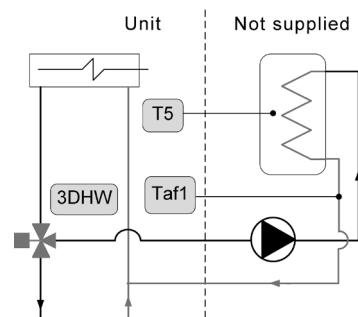

Connection diagram for connecting the individual module for producing domestic hot water

If the system is satisfied (unit off):

When the temperature probe (T5), supplied by Clivet and positioned inside the storage calls for production of DHW, the unit dedicated to DHW activates, changing the set-point from set system to set DHW and diverts the water flow through the built-in 3-way valve. The unit will remain active until the DHW set-point has been satisfied, then it will shut-off.

If the system has a request (unit is on):

When the temperature probe (T5) sends a request for production of DHW, the unit dedicated to DHW, which is already active for the system stops, the cycle changes and if producing cooled water, the set-point changes from set system to set DHW and diverts the water flow through the built-in 3-way valve. The unit will remain active until the DHW set-point has been satisfied, then it will return to producing the system.

Dimensional drawings

Size 10.1 - 12.1 -14.1

DABND0002_00
Data/Date 23/06/2020

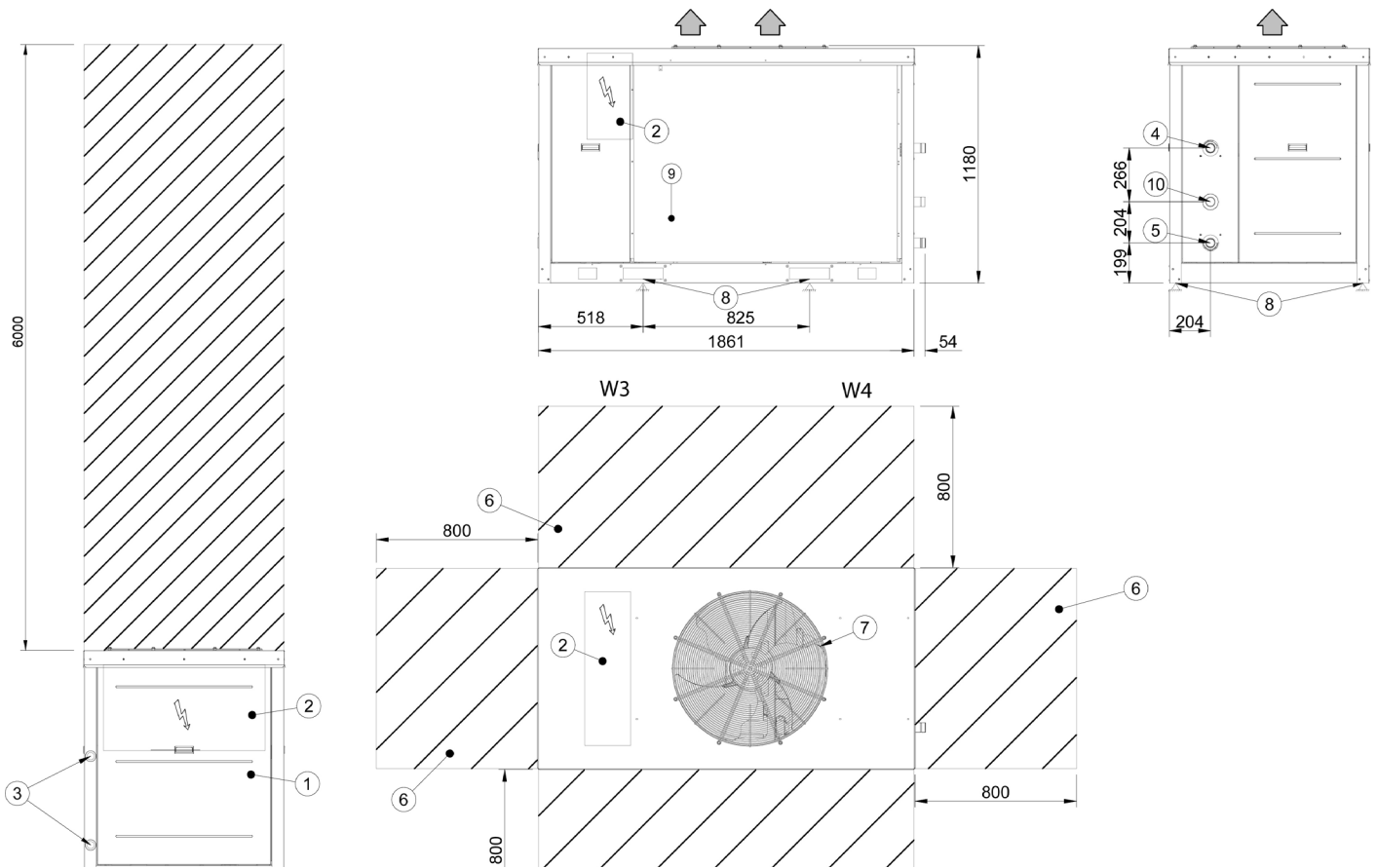

1. Compressor compartment
2. Electrical panel
3. Power input
4. Inlet water connection 1" 1/2 Victaulic
5. Outlet water connection 1" 1/2 Victaulic
6. Functional spaces
7. Electric fan
8. Unit fixing holes
9. External exchanger
10. DHW outlet (optional) 1 1/2" Victaulic

SIZE		10.1	12.1	14.1
Length	mm	1861	1861	1861
Depth	mm	991	991	991
Height	mm	1180	1180	1180
Operating weight	kg	298	298	298
Shipping weight	kg	298	298	298

The presence of optional accessories may result in a substantial variation of the weights shown in the table.

Size 16.2 - 18.2 - 22.2

DABND0003_00
Data/Date 23/06/2020

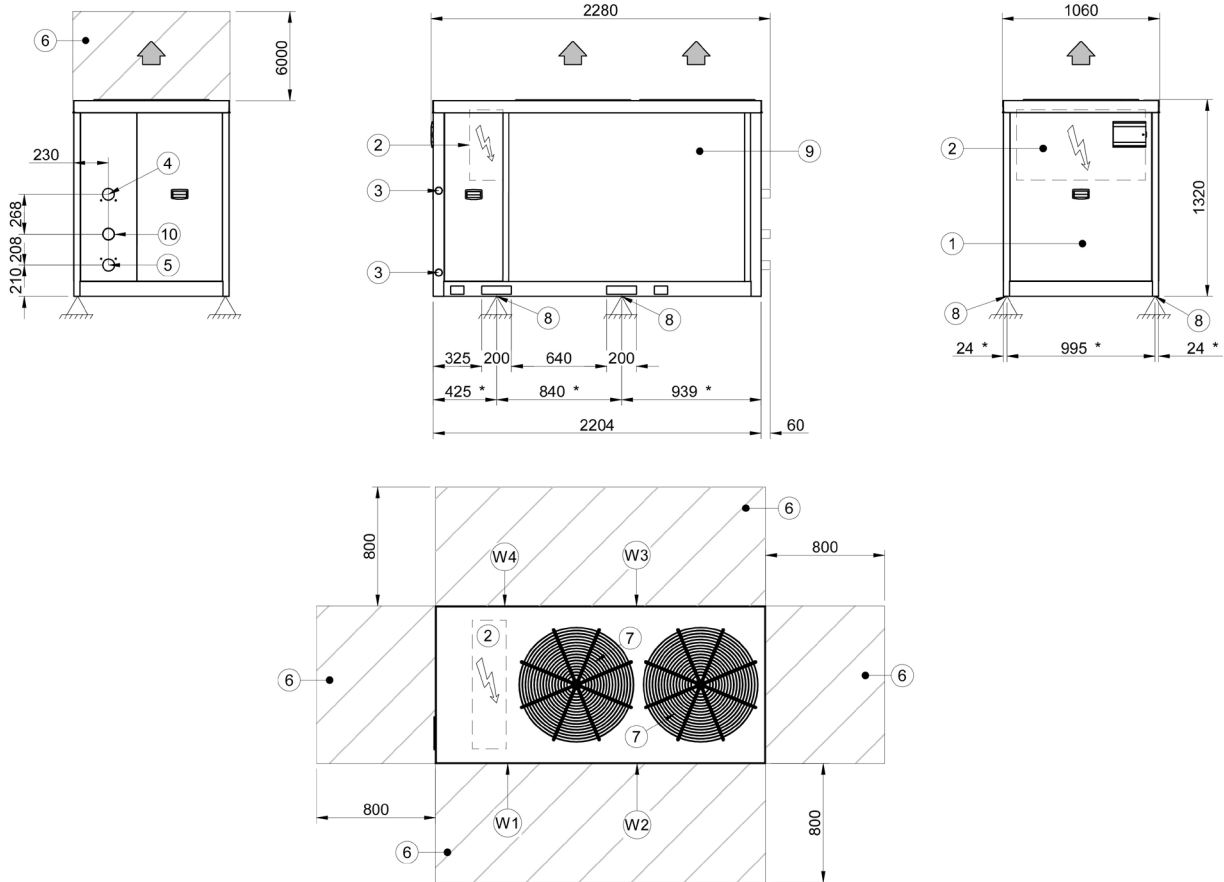

1. Compressor compartment
2. Electrical panel
3. Power input
4. Inlet water connection 2" Victaulic
5. Outlet water connection 2" Victaulic
6. Functional spaces
7. Electric fan
8. Unit fixing holes
9. External exchanger
10. DHW outlet (optional) 2" Victaulic

SIZE		16.2	18.2	22.2
Length	mm	2204	2204	2204
Depth	mm	1042	1042	1042
Height	mm	1326	1326	1326
Operating weight	kg	530	530	530
Shipping weight	kg	530	530	530

The presence of optional accessories may result in a substantial variation of the weights shown in the table.

Dimensional drawings

Size 30.2 - 35.2 - 40.2

DACND0003_00
Data/Date 07/04/2021

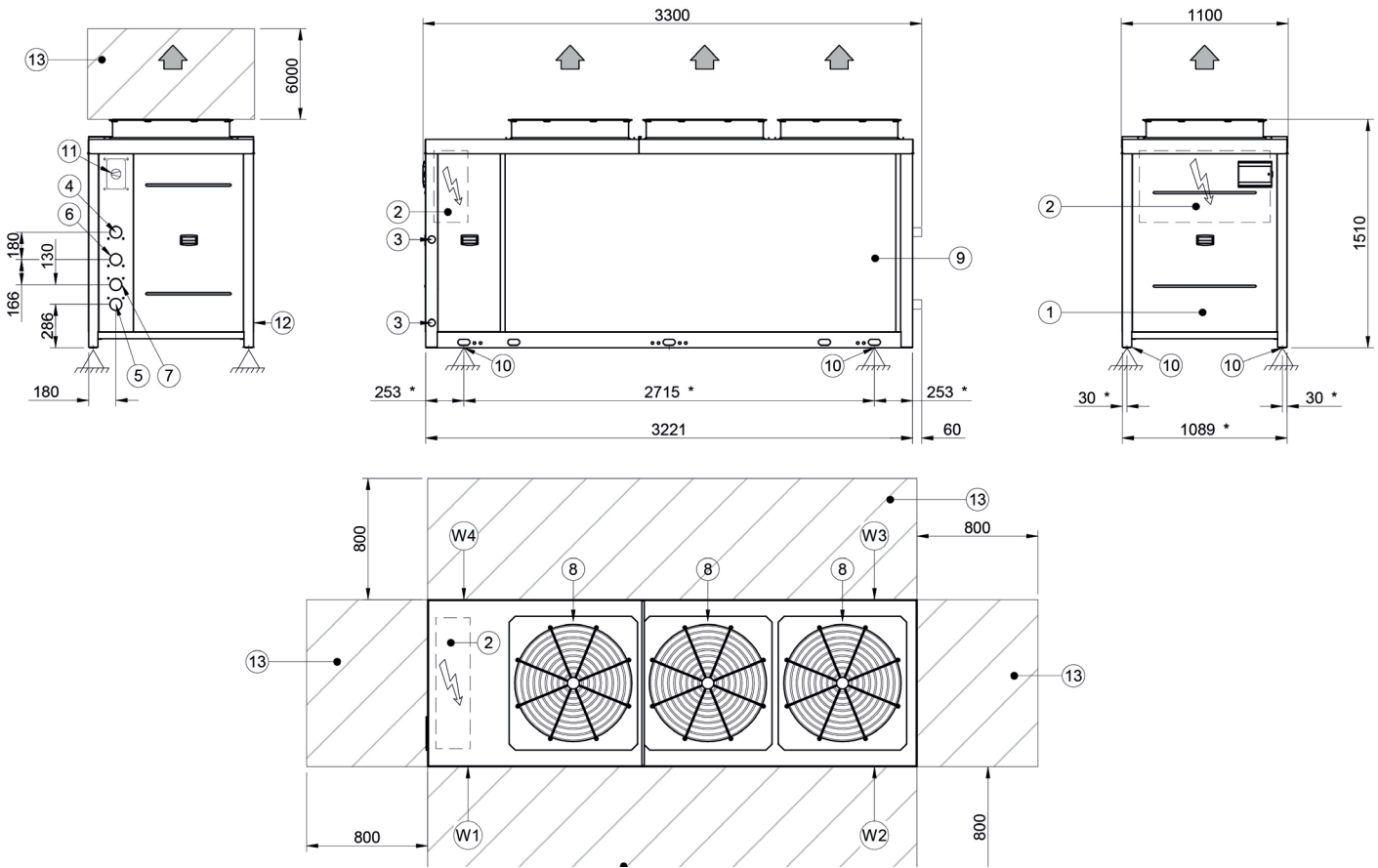

1. Compressor compartment
 2. Electrical panel
 3. Power input
 4. Inlet water connection 2" Victaulic
 5. Outlet water connection 2" Victaulic
 6. Inlet DHW connection 2" Victaulic
 7. Outlet DHW connection 2" Victaulic
 8. Electric fan
 9. External exchanger
 10. Unit fixing holes
 11. Main switch (option)
 12. Power input main switch (option)
 13. Functional spaces
- * Vibration mounts position

SIZE		30.2	35.2	40.2
Length	mm	3221	3221	3221
Depth	mm	1089	1089	1089
Height	mm	1510	1510	1510
Operating weight	kg	830	830	830
Shipping weight	kg	830	830	830

The presence of optional accessories may result in a substantial variation of the weights shown in the table.

DA OLTRE 30 ANNI OFFRIAMO
SOLUZIONI PER IL COMFORT
SOSTENIBILE E IL BENESSERE
DELL'INDIVIDUO E DELL'AMBIENTE

www.clivet.com

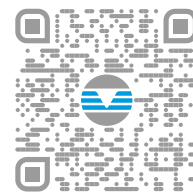

vendita e assistenza

ELFOenergy SHHEN EVO - WSAN YSi - BT



CLIVET SPA

Via Camp Lonc 25, Z.I. Villapaiera
32032 Feltre (BL) - Italy
Tel. +39 0439 3131 - Fax +39 0439 313300
info@clivet.it

A Group Company of

