



WSAN-YSi

10.1 - 40.2

MANUAL

FOR INSTALLATION,
USE AND MAINTENANCE



M0ND00023-00 07-21

R32

Dear Customer,

We congratulate you on choosing this product

Clivet has been working for years to offer systems able to assure the maximum comfort for a long time with highly-reliable, efficient, high-quality and safe solutions. The target of the company is to offer advanced systems, that assure the best comfort and reduce energy consumption as well as the installation and maintenance costs for the entire life-cycle of the system.

With this manual, we want to give you information that are useful for all phases: from reception, installation and use to disposal - so that such an advanced system can provide the best performances during installation and use.

Best regards and have a good read.

CLIVET Spa

The data contained in this manual is not binding and may be changed by the manufacturer without prior notice. Reproduction, even partial, is FORBIDDEN. © Clivet S.p.A. - Feltre (BL) - Italia

1	Safety considerations	4
2	Information on refrigerant gas	7
3	Before installing	8
4	Selecting the installation site	10
5	Water connections	12
6	Electrical connections	18
7	Start-up	24
8	Control	30
9	Troubleshooting	43
10	Safety warning - R32	49
11	Maintenance	52
12	Disposal	57
13	Residual risk	58
14	Unit in modular configuration	60
15	Technical data	64

Safety

Operate in compliance with safety regulations in force.

To carry out the operations use protection devices:

gloves, goggles, helmet, headphones, protective knee pads.

All operations must be carried out by personnel trained on possible risks of a general nature, electrical and deriving from operating with equipment under pressure.

Only qualified personnel can operate on the unit, as required by the regulation in force.

Manual

The manual provides correct unit installation, use and maintenance.

It is advisable to read it carefully so you will save time during operations.

Follow the written indications so you will not cause damages to things and injuries people.

Risk situations

The unit has been designed and created to prevent injuries to people.

During designing it is not possible to plane and operate on all risk situation.

Read carefully “Residual risk” section where all situation which may cause damages to things and injuries to people are reported.

Installation, starting, maintenance and repair required specific knowledge; if they are carried out by inexperienced personnel, they may cause damages to things and injuries people.

Intended use

Use the unit only:

- cooling water or a water and glycol mix for air-conditioning
- keep to the limits foreseen in the technical schedule and in this manual

The manufacturer accepts no responsibility if the equipment is used for any purpose other than the intended use.

Installation

Outdoor installation

The positioning, hydraulic system, refrigerating, electrics and the ducting of the air must be determined by the system designer in accordance with local regulations in force.

Follow local safety regulations.

Verify that the electrical line characteristics are in compliance with data quotes on the unit serial number label.

Maintenance

Plan periodic inspection and maintenance in order to avoid or reduce repairing costs.

Turn the unit off before any operation.



Before any work read:

⇒ Chapter. SAFETY WARNINGS FOR OPERATIONS ON UNITS CONTAINING R32



Pay particular attention to:

⇒ warnings / prohibitions / danger indicating particularly important operations or information, operations that cannot be done, which compromise the functionality of the unit or which may cause damage to things or persons.

Outdoor installation

Modification

All unit modifications will end the warranty coverage and the manufacturer responsibility.

Breakdown/Malfunction

Disable the unit immediately in case of breakdown or malfunction.

Contact a certified service agent.

Use original spares parts only.

Using the unit in case of breakdown or malfunction:

- voids the warranty
- it may compromise the safety of the unit
- it may increase time and repair costs

User training

The installer has to train the user on:

- start-up/shutdown
- set points change
- standby mode
- maintenance
- what to do / what not to do in case of breakdown.

Data update

Continual product improvements may imply manual data changes.

Visit manufacturer web site for updated data.

Indications for the User

Keep this manual with the wiring diagram in an accessible place for the operator.

Note the unit data label so you can provide them to the assistance centre in case of intervention (see "Unit identification" section).

Provide a unit notebook that allows any interventions carried out on the unit to be noted and tracked making it easier to suitably note the various interventions and aids the search for any breakdowns.

In case of breakdown or malfunction

- Immediately deactivate the unit
- Contact a service centre authorized by the manufacturer

The installer must train the user, particularly on:

- Start-up/shutdown
- Set points change
- Standby mode
- Maintenance
- What to do / what not to do in case of breakdown

Unit identification

The serial number label is positioned on the unit and allows to identify all the unit features.

The matriculation plate shows the indications foreseen by the standards, in particular:

- unit type
- serial number (12 characters)
- year of manufacture
- wiring diagram number
- electrical data
- type of refrigerant
- refrigerant charge
- manufacturer logo and address

The matriculation plate must never be removed.

It contains fluorinated greenhouse gases.

Serial number

It identifies uniquely each unit.

Must be quoted when ordering spare parts.

Assistance request

Note data from the serial number label and write them in the chart on side, so you will find them easily when needed.

Series
Size
Serial number
Year of manufacture
Number of electrical wiring diagram

Accessories supplied

T5 - DHW storage temperature probe	1	A
Taf1 - DHW storage antifreeze probe	1	A
TW - Leaving water probe (pre-installed on the unit's supply pipe)	1	B
Tw probe trap	1	A
Transformer for keypad power supply	1	A
Victaulic couplings for hydraulic pipe connections	2	B

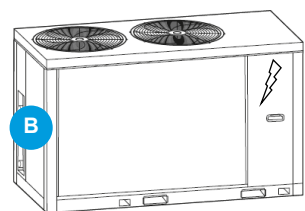
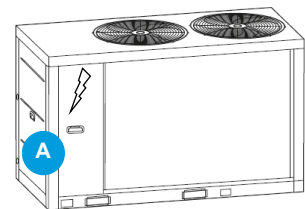

This product contains fluorinated greenhouse gases covered by the Kyoto protocol. Do not discharge gas into air.

Refrigerant type: R32

The refrigerant quantity is indicated on the unit plate

Quantity factory-loaded refrigerant and equivalent CO₂ tons:

Size	Refrigerant (Kg)	Equivalent CO ₂ tons
10.1-14.1	7,9	5,533
16.2-22.2	14	9,45
30.2-40.2	17,5	11,8

Physical characteristics of the R32 refrigerant		
Safety class (ISO 817)	A2L	
GWP	675	
LFL Low flammability limit	0.307	kg/m ³ @ 60°C
BV Burning velocity	6,7	cm/s
Punto di ebollizione	-52	°C
GWP	675	100 yr ITH
GWP	677	ARS 100 yr ITH
Self-ignition temperature	648	°C

Reception

You have to check before accepting the delivery:

- That the unit hasn't been damaged during transport
- That the materials delivered correspond with that indicated on the transport document comparing the data with the identification label positioned on the packaging.

In case of damage or anomaly:

- write down on the transport document the damage you found and quote this sentence: "Conditional acceptance clear evidence of deficiencies/damages during transport"
- contact by fax and registered mail with advice of receipt to supplier and the carrier.

NOTE

⇒ Any disputes must be made within 8 days from the date of the delivery. Complaints after this period are invalid .

Storage

Respect the indications on the outside of the pack.

In particular:

- ⇒ minimum ambient temperature -20°C
(possible components damages)
- ⇒ maximum ambient temperature $+48^{\circ}\text{C}$
(possible safety valve opening)
- ⇒ maximum relative humidity 95%
(possible damages to electrical components)

NOTE

⇒ The unit may not be tilted more than 15° during transport.

NOTE

Removal of packaging

Be careful not to damage the unit.

Recycle and dispose of the packaging material in compliance with local regulations.

Suitably protect the unit to prevent damage.

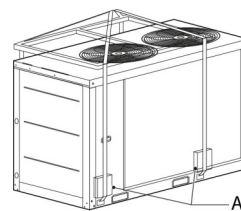

spacer bar

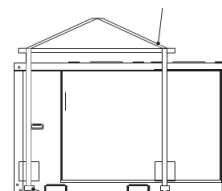

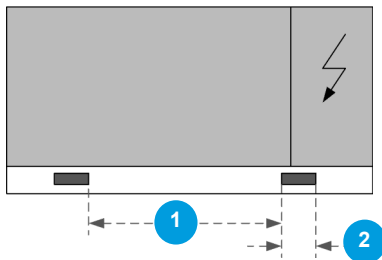
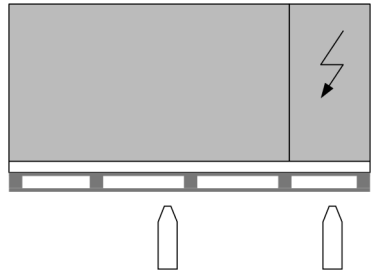
		10.1-14.1	16.2-22.2	
	1	630	640	
	2	200	200	
				
30.2-40.2				
Unit on pallet				
				

Handling

- ⇒ Check that all handling equipment complies with local safety regulations (cran, forklifts, ropes, hooks, etc.).
- ⇒ Provide personnel with personal protective equipment suitable for the situation, such as helmet, gloves, accident-prevention shoes, etc.
- ⇒ Observe all safety procedures in order to guarantee the safety of the personnel present and the of material..

Lifting

1. Verify unit weight and handling equipment lifting capacity.
2. Identify critical points during handling (disconnected routes, flights, steps).
3. Suitably protect the unit to prevent damage.
4. Lifting with balance
5. Lifting with spacer bar
6. Align the barycenter to the lifting point
 - Gradually bring the lifting belts under tension, making sure they are positioned correctly.
 - Before starting the handling, make sure that the unit is stable..

1



2

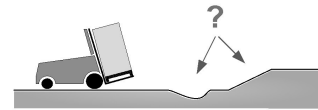

3

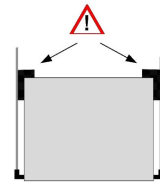

4

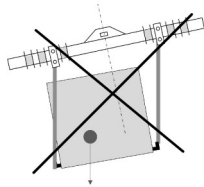
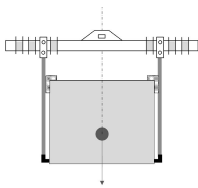

6

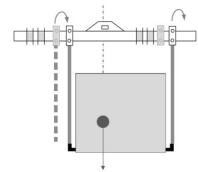

5

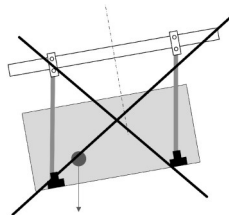
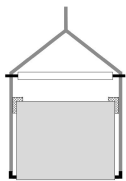

6

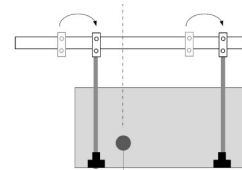

General informations

⇒ Installation must be in accordance with local regulations. If they do not exist, follow EN378.

During positioning consider these elements:

- customer approval
- unit weight and bearing point capacity
- safe accessible position
- functional spaces
- spaces for the air intake/exhaust
- electrical connections
- max. distance allowed by the electrical connections
- water connections

Functional spaces

Functional spaces are designed to:

- guarantee good unit operation
- carry out maintenance operations
- protect authorized operators and exposed people

⇒ Respect all functional spaces indicated in the TECHNICAL INFORMATION section.

Positioning

Units are designed to be installed:

- EXTERNAL
- in fixed positions

⇒ Put the unit in a position where any leaking gas cannot enter buildings or stagnate in closed areas. In the latter case, observe the rules for machinery rooms (ventilation, leak detection, etc.).

Installation standards:

- install the unit raised from the ground
- bearing points aligned and leveled
- discharged condensation water must not cause harm/danger to people and property
- the accumulation of snow must not cause clogging of the coils
- avoid installations in places subject to flooding

Limit vibration transmission:

- use anti-vibration devices or neoprene strips on the unit support points
- install flexible joints on the hydraulic connections

Protect the unit with suitable fence in order to avoid access to unauthorised personnel (children, vandals, etc.)

A correct circulation of the air is mandatory to guarantee the good unit operating.

Functional spaces Safety Zone

See chapt. TECHNICAL DATA
Do not smoke or use open flames
within this area

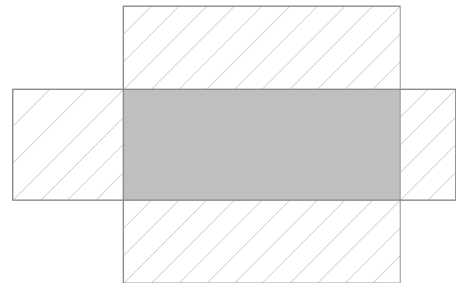

The unit must be level.

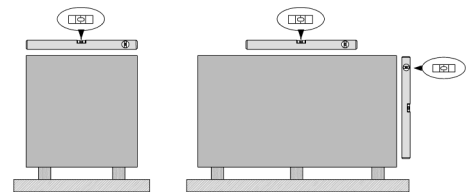

Do not go up to the surface

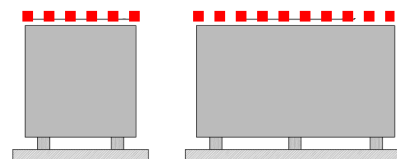

Avoid therefore:

- obstacles to the airflow
- exchange difficulties
- leaves or other foreign bodies that can obstruct the exchange batteries
- winds that hinder or favour the airflow
- heat or pollution sources close to the unit (chimneys, extractors etc)
- stratification (cold air that stagnates at the bottom)
- recirculation (expelled air that is sucked in again)
- positioning below the level of the threshold, close to very high walls, attics or in angles that could give rise to stratification or recirculation phenomenons.

Ignoring the previous indications could:

- energy efficiency decrease
- alarm lockout due to HIGH PRESSURE (in summer) or LOW PRESSURE (in winter)

Prevent the accumulation of snow.

Batteries and fans must always be kept free from obstacles, accumulated leaves, snow, etc.

If the unit is installed where it might snow:

- do not install the unit under trees or roofs that may accumulate snow
- envisage a base of a suitable height for a possible accumulation of snow.

Otherwise the accumulated snow will block the airflow and may cause problems to the equipment.

Condensate

When a heat pump is in operation it produces a considerable amount of water due to the defrosting cycles of the external coil. The condensate must be disposed of in order to avoid damaging people and things..

Pressure relief valve gas side

The installer is responsible for evaluating the opportunity of installing drain pipes in compliance with the local regulations in force (EN 378).

If ducted, the valves must be sized according to EN13136 .

Installation of the antivibration mounts

Place the antivibration mounts between the unit and the base.
Use the holes on the unit frame (15 mm diameter).

NOTE

⇒ If spring antivibration units are also installed, the total height of the unit increases.

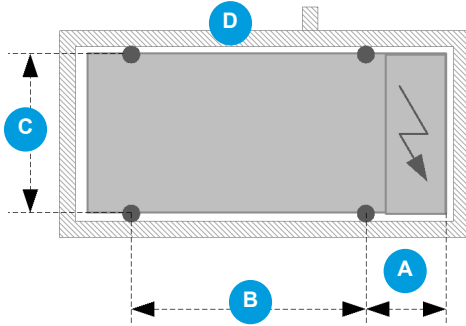

	10.1-14.1	16.2-22.2	30.2-40.2
A	518	425	253
B	825	840	2715
C	930	995	1029
D	Condensate collection channel		

Antivibration mounts kit - Option

10.1-14-1				
Unit version	Standard	Con accumulo	Standard	With tank
Antivibration mounts	Standard	Standard	Anti-seismic	Anti-seismic
Kit PE	PEND00010	PEND00029	PEND00031	PEND00030
W1	BBS100-45Sh	BBS100-60Sh	LaLrLv 14	LaLrLv 22
W2	BBS100-35Sh	BBS100-45Sh	LaLrLv 9	LaLrLv 14
W3	BBS100-45Sh	BBS100-60Sh	LaLrLv 14	LaLrLv 22
W4	BBS100-35Sh	BBS100-45Sh	LaLrLv 9	LaLrLv 14

16.2—22.2				
Unit version	Standard	With tank	Standard	With tank
Antivibration mounts	Standard	Standard	Anti-seismic	Anti-seismic
Kit PE	PEND00029	PE2S00001	PEND00030	PEND00032
W1	BBS100-60Sh	BBS100-60Sh	LaLrLv 22	LaLrLv 300
W2	BBS100-45Sh	BBS100-60Sh	LaLrLv 14	LaLrLv 30
W3	BBS100-60Sh	BBS100-60Sh	LaLrLv 22	LaLrLv 300
W4	BBS100-45Sh	BBS100-60Sh	LaLrLv 14	LaLrLv 300

30.2—40.2				
Unit version	Standard	With tank	Standard	With tank
Antivibration mounts	Standard	Standard	Anti-seismic	Anti-seismic
Kit PE	PEND00020	PEND00021	PEND00023	PEND00024
W1	RQZ 402-Z108	RQZ 408-X104	LaLrVr 33	LaLrVr 50
W2	RQZ 403-X102	RQZ 405-X103	LaLrVr 22	LaLrVr 31
W3	RQZ 403-X102	RQZ 405-X103	LaLrVr 22	LaLrVr 31
W4	RQZ 402-Z108	RQZ 408-X104	LaLrVr 33	LaLrVr 50

Hydraulic system

The pipes must be designed and manufactured to limit pressure drops as much as possible, i.e. optimise performance of the system. Keep the following to a minimum:

- overall length
- number of bends
- changes of direction

Water quality

The water quality can be checked by qualified personnel.

Water with inadequate characteristics can cause:

- pressure drop increase
- energy efficiency decrease
- corrosive symptom increase

Water features:

- within the limits indicated by table

Provide a water treatment system if values fall outside the limits.

Cleanliness

Before connecting the water to the unit, clean the system thoroughly with specific products effective to remove residues or impurities that may affect functioning.

Existing systems must be free from sludge and contaminants and protected against build-ups.

New systems

In case of new installations, it is essential to wash the entire installation (with the circulator uninstalled) before commissioning the central installation. This removes residues of the installation process (welding, waste, joint products...). The system must then be filled with clean high-quality tap water.

Existing systems

If a new unit is installed on an existing system, the system must be rinsed to avoid the presence of particles, sludge and waste. The system must be drained before installing the new unit.

Dirt can be removed only with a suitable water flow.

Each section must then be washed separately.

Particular attention must also be paid to "blind spots" where a lot of dirt can accumulate due to the reduced water flow.

The system must then be filled with clean high-quality tap water. If, after rinsing, the quality of the water is still unsuitable, a few measures must be taken to avoid problems.

An option to remove pollutants is to install a filter.

The warranty does not cover damages caused by limestone formations, deposits and impurities from the water supply and/or from failure to clean the systems.

Water component for corrosion limit on Copper

PH (25°C)	7,5 ÷ 9,0
SO ₄ ²⁻	< 100
HCO ₃ ⁻ / SO ₄ ²⁻	> 1
Total Hardness	8 ÷ 15 °f
Cl ⁻	< 50 ppm
PO ₄ ³⁻	< 2,0 ppm
NH ₃	< 0,5 ppm
Free Chlorine	< 0,5 ppm
Fe ₃ ⁺	< 0,5 ppm
Mn ⁺⁺	< 0,05 ppm
CO ₂	< 50
H ₂ S	< 50 ppb
Oxygen content	< 0,1 ppm
Sand	10 mg/L
Ferrite hydroxide Fe ₃ O ₄ (black)	Dose < 7.5 mg/L 50% of mass diameter < 10 µm
Iron oxide Fe ₂ O ₃ (red)	Dose < 7.5mg/L Diameter < 1 µm
Electrical conductivity (µS/cm)	<500
Sodium nitrate (mgNaNO ₃ /l)	<100
Alkalinity(mgCaCO ₃ /l)	<100
Copper (mgCu/l)	<1.0
Sulphide ion (S ⁻ /l)	None
Ammonium ion (mgNH ₄ ⁺ /L)	<1.0
Silica (mgSiO ₂ /l)	50
Max Ethylene, Propylene glycol	50%
Nitrates	<100
Free&aggressive Carbonic Acid	<5

Risk of freeze

If the unit or the relative water connections can be subject to temperatures close to 0°C:

- Mix water with ethylene glycol, or
- Safeguard the pipes with heating cables placed under the insulation, or
- Empty the system in cases of long non-use

Anti-freeze solutions

Consider that the use of anti-freeze solution determines an increase in a pressure drop.

Make sure that the glycol type utilized is inhibited (not corrosive) and compatible with the hydraulic circuit components.

Do not use different glicol mixture (i.e. ethylic with propylene).

The unit must always be protected from freeze. Otherwise irreversible damage may occur.

% ETHYLENE / PROPYLENE GLYCOL BY WEIGHT		5%	10%	15%	20%	25%	30%	35%	40%	45%	50%
Freezing temperature	°C	-2	-3.9	-6.5	-8.9	-11.8	-15.6	-19.0	-23.4	-27.8	-32.7
Safety temperature	°C	3	1	-1	-4	-6	-10	-14	-19	-23.8	-29.4

Water filter

⇒ *Must be installed immediately in the water input of the unit, in a position that is easily accessible for cleaning.*

⇒ *The filter never should be removed, this operation invalidates the guaranty.*

The filter must have an adequate mesh to prevent the entry of particles greater than:

0,5 mm (30 mesh)

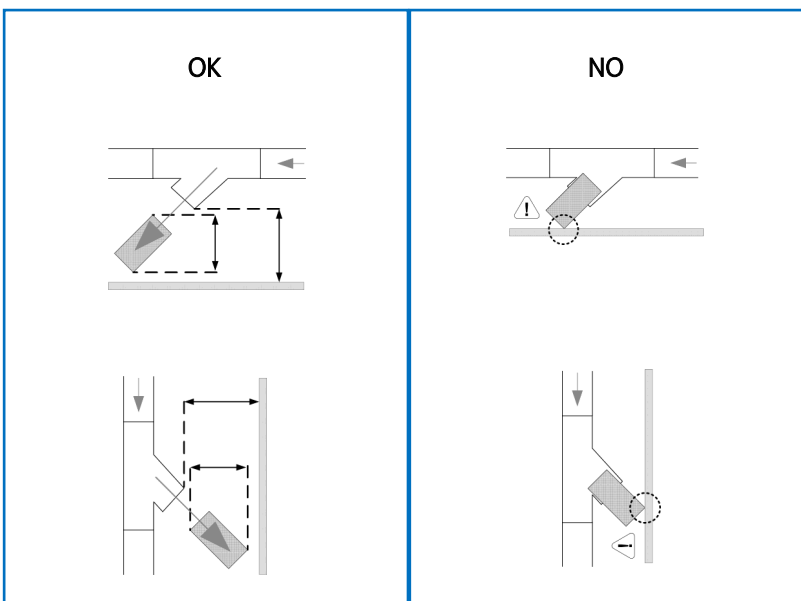

Water flow-rate

The design water flow-rate must be:

- inside the exchanger operating limits (see the TECHNICAL DATA chapter)
- guaranteed also with variable system conditions (for example, in systems where some circuits are bypassed in particular situations)

If the system capacity is below the minimum flow, bypass the system as indicated in the diagram.

If the system capacity exceeds the maximum flow, bypass the system as indicated in the diagram.

Non-return valve

Provide for the installation of non-return valves (A) in the case of several units connected in parallel.

Domestic hot water

See ELECTRICAL connections.

Minimum water flow

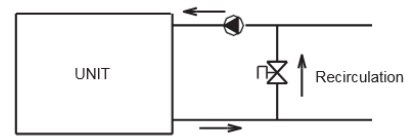

Maximum water flow

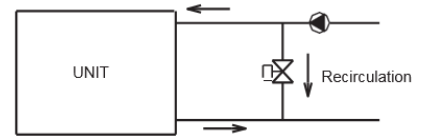

Non-return valve

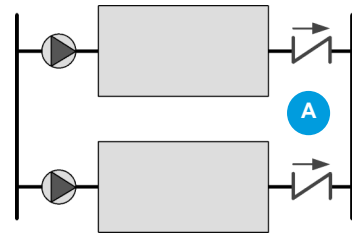

Standard Unit

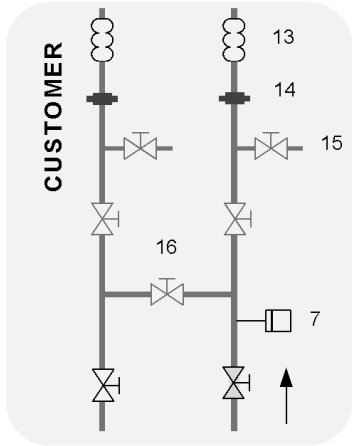
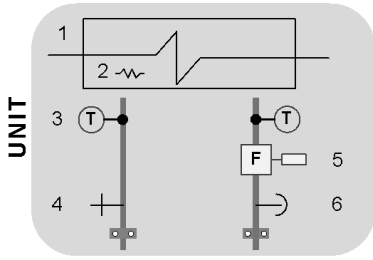

Unit + pump

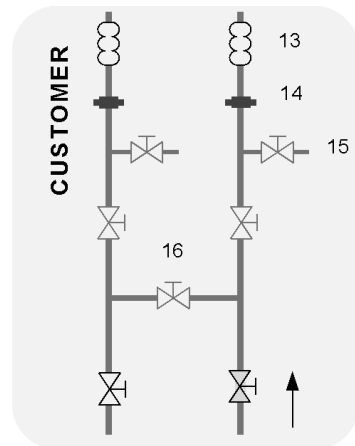
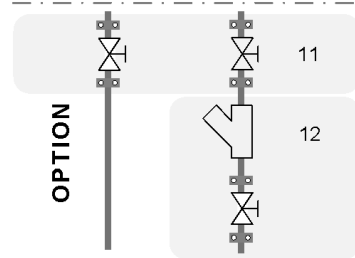
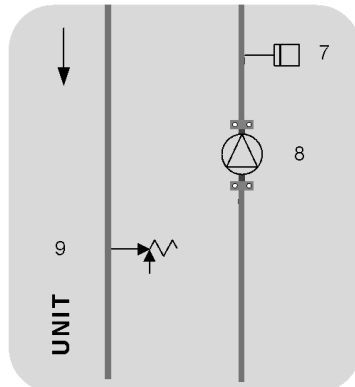
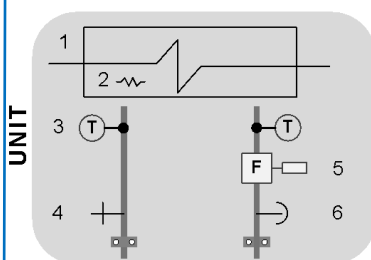

- 1 exchanger
- 2 antifreeze heater
- 3 water temperature probe
- 4 drain
- 5 water flow switch
- 6 vent
- 7 system loading safety pressure switch
- 8 pump
- 9 safety valve
- 10 N.D.
- 11 shut-off valves
- 12 filter
- 13 flexible couplings
- 14 piping supports
- 15 exchanger chemical cleaning bypass
- 16 system cleaning bypass
- 17 N.D.

Unit + storage tank

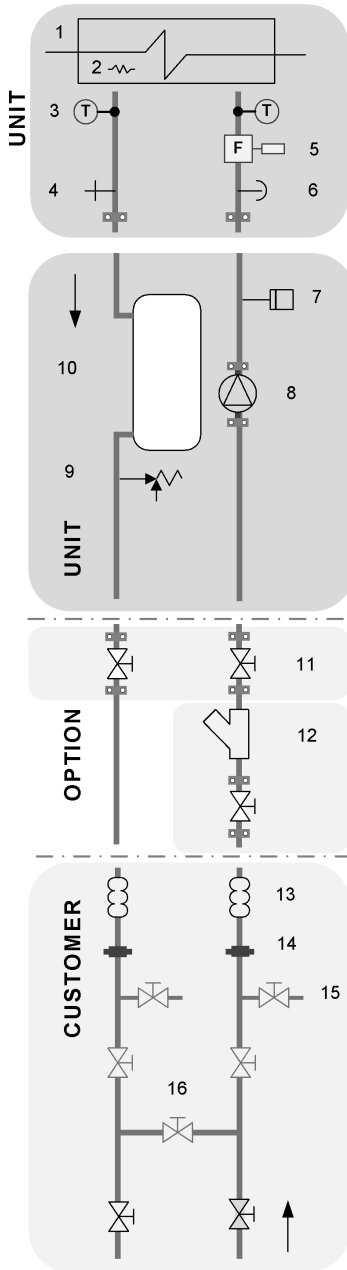

Unit + 3-way valve

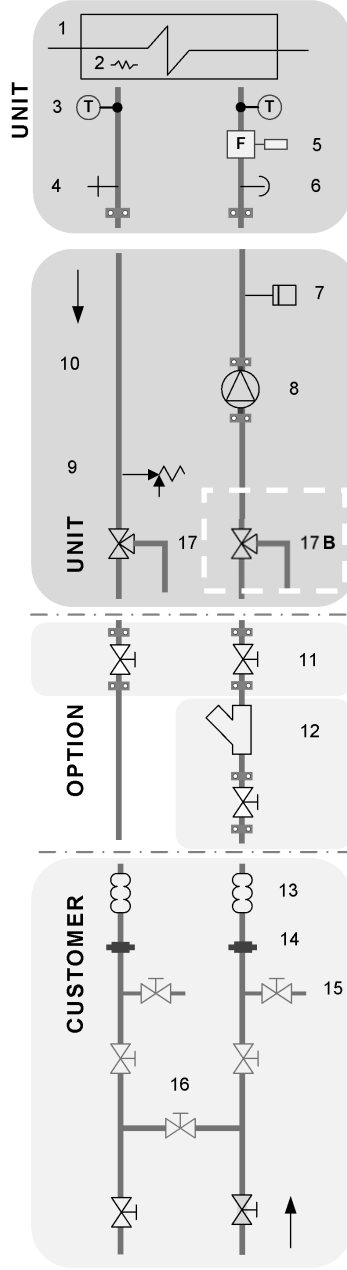

- 1 exchanger
- 2 antifreeze heater
- 3 water temperature probe
- 4 drain
- 5 water flow switch
- 6 vent
- 7 system loading safety pressure switch
- 8 pump
- 9 safety valve
- 10 storage tank
- 11 shut-off valves
- 12 filter
- 13 flexible couplings
- 14 piping supports
- 15 exchanger chemical cleaning bypass
- 16 system cleaning bypass
- 17 domestic hot water valve (10.1-22.2)
- 17B domestic hot water valve (30.2-40.2)

Victaulic connections

- 1 take away the supplied connection union by acting on the connection joint
- 2 weld the union to the installation pipe
- 3 perform the connection between the installation pipe and the evaporator, using the joint

Do not weld the system pipe with the Victaulic connection joint attached.

The rubber gasket might be irreparably damaged.

Operations sequence

Before starting the unit pump:

- 1 Close all vents in the high points of the unit's water circuit.
 - 2 Close all drain shut-off valves in the low points of the unit's water circuit
 - Exchangers
 - Pumps
 - collectors
 - storage tanks
 3. Thoroughly wash the system with clean water: use the bypass to exclude the exchanger from the flow (diagram on previous page) fill and drain the system several times.
 4. Apply additives to prevent corrosion, fouling, formation of mud and algae.
 5. Fill the system
do not use the unit pump
 6. Conduct a leak test.
 7. Isolate the pipes to avoid heat dispersions and formation of condensate.
 8. Leave various service points free (wells, vents, etc).
- ⇒ *Neglecting to wash will lead to the filter having to be cleaned many times and at worst may damage the exchangers and compressors.*

Victaulic

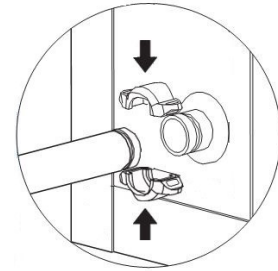

The characteristics of the electrical lines must be determined by specialized personnel able to design electrical installations; moreover, the lines must be in conformity with regulations in force.

The protection devices of the unit power line must be able to stop the presumed short circuit current, whose value must be determined in function of system features.

The power cables and the protection cable section must be defined in accordance with the characteristics of the protections adopted.

All electrical operations should be performed by trained personnel having the necessary requirements by the regulations in force and being informed about the risks relevant to these activities.

Operate in compliance with safety regulations in force.

Electrical data

The serial number label reports the unit specific electrical data, included any electrical accessories.

The electrical data indicated in the technical bulletin and in the manual refer to the standard unit, accessories excluded.

Refer to the electrical data report on the serial number label:

- Tensione
- F.L.A.: full load ampere, absorbed current at maximum admitted conditions
- F.L.I.: full load input, full load power input at max. admissible condition
- Electrical wiring diagram Nr

Connections

- 1 Refer to the unit electrical diagram (the number of the diagram is shown on the serial number label).
- 2 verify that the network has characteristics conforming to the data shown on the serial number label.
- 3 Before starting work, verify that the sectioning device at the start of the unit power line is open, blocked and equipped with cartel warning.
- 4 Primarily you have to realize the earthing connection.
- 5 Shelter the cables using adequate measure fairleads.
- 6 Prevent dust, insects or rodents from entering the electrical panel as they can damage components and cables.
- 7 Prevent noise from escaping from the compressor compartment; seal any openings made.
- 8 Secure the cables: if left unattached they can be stripped.
- 9 The cables must not touch the compressors or the refrigerant piping (they reach high temperatures).
- 10 Do not drill holes in the electrical panel.
Alternatively, restore the IP rating with watertight systems.
- 11 Before power the unit, make sure that all the protections that were removed during the electrical connection work have been restored.

Isolating switch

Option

Only size 16.2-40.2

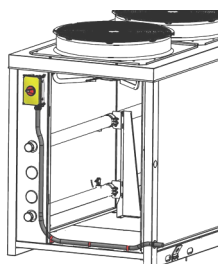

Power In

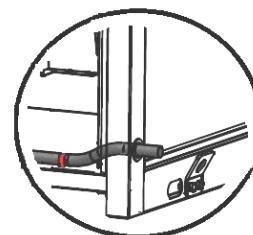

Signals / data lines

Do not overpass the maximum power allowed, which varies, according to the type of signal.

Lay the cables far from power cables or cables having a different tension and that are able to emit electromagnetic disturbances.

Do not lay the cable near devices which can generate electromagnetic interferences.

Do not lay the cables parallel to other cables; cable crossings are possible, only if laid at 90°.

In case of parallel power supply and signal cables, use separate metal ducts. Minimum distance between power supply and signal cables:

- 300 mm for absorption up to 10A.
- 500 mm for absorption up to 50A.

Connect the screen to the ground, only if there aren't disturbances.

Guarantee the continuity of the screen during the entire extension of the cable.

Respect impedance, capacity and attenuation indications.

Power supply cables section

	10.1 - 14.1	16.2 - 22.2	30.2 - 40.2
Max. cable section Cu (mm²)	16	25	25

Power supply network requirements

- 1 The short circuit capacity of the line must be less than 15 kA
- 2 The units can only be connected to TN, TT distribution systems
- 3 Voltage 400-3-50 +/-10%
- 4 Phase unbalance < 2%
- 5 Harmonic distortion less than 12% (THDv<12%)
- 6 Voltage interruptions lasting no longer than 3ms and with at least 1 s between each one
- 7 Voltage dips not exceeding 20% of the RMS value, lasting no longer than a single period (50Hz) and with at least 1 s between each dip.
- 8 Earth cable as specified in the table:

Cross-section of the line conductors (mm ²)	Minimum cross-section of the protective conductor (PE) (mm ²)
$S \leq 16$	S
$16 < S \leq 35$	16
$S > 35$	S/2

EMC filter

Option available for installation in residential, commercial and light industrial environments for conducted emissions (direct connection to the public grid).

It allows the unit to be installed in residential, commercial or light industrial environments, reducing electromagnetic interference.

ALM	Segnalazione blocco cumulativo Cumulative fault signal Signalisation alarme Sammelstörmeldung Señalización bloqueo cumulativo	ON/OFF	Selettore ON/OFF remoto Remote ON/OFF selector Selector de ON/OFF remoto Remote ON/OFF Wahlschalter Selector de ON/OFF remoto
COOL/HEAT	Selettore remoto "estate/inverno" Remote winter/summer selector Sélecteur déporté "été/hiver" Fernwahlschalter Winter/Sommer Selector remoto "verano/invierno"	SPA2	Pressostato controllo carico impianto System charge control pressure switch Selector de ON/OFF remoto Remote ON/OFF Wahlschalter Selector de ON/OFF remoto
HLC1	Lampada di segnalazione stato compressore Compressor status signal lamp Lampe de signalisation état compresseur Signalilampe Verdichtierzustand Lámpara de señalización estado compresor	TAF1	Sensore antigelo su acqua lato ACS Anti-freeze sensor on water on DHW side Sonda anticongelante lado ACS Frostschutzsensor auf der Warmwasserseite Sonda anticongelante lado ACS
KA-H1	Relè di comando resistenza ausiliaria tubatura acqua Control Relay for pipeline Auxiliary Heater Relais de commande de chauffage auxiliaire de conduite d'eau Steuerrelais für Zusatzheizung der Wasserleitung Relé de control del calentador auxiliar de la tubería de agua	TEMP SW	Selettore remoto per cambio set-point Remote selector for set-point change Sélecteur à distance pour le changement de point de consigne Fernwahlschalter für Sollwertänderung Selector remoto para cambio de punto de ajuste
KA-H2	Relè di comando resistenza ausiliaria accumulo acqua sanitaria Control relay for sanitary water storage tank auxiliary heater Relais de commande de résistance auxiliaire pour stockage d'eau chaude sanitaire Hilfswiderstandsregelrelais für die Warmwasserspeicherung Relé de control de calefacción auxiliar para almacenamiento de agua caliente sanitaria	T5	Sonda di temperatura accumulo acqua calda sanitaria Domestic hot water storage temperature probe Sonde de température de stockage d'eau chaude sanitaire Brauchwasserspeicher-Temperaturfühler Sonda de temperatura de almacenamiento de agua caliente sanitaria
KMU	Contattore di comando pompa a carico cliente Pump control contactor provided by the customer Contacteur commande pompe à la charge du client Kundenseitiger Schaltegeber Pumpensteuerung Contactor de accionamiento bomba a cargo del cliente		

Collegamenti a cura del cliente
Connections performed by customer
Raccordements à la charge du client
Kundenseitige Anschlüsse
Conexiones a cargo del cliente

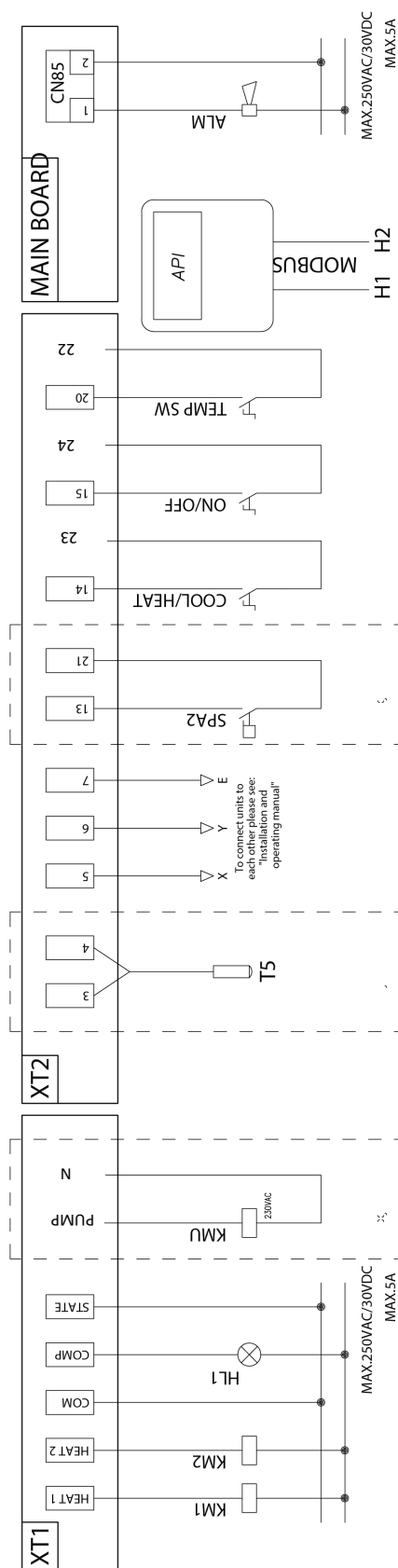
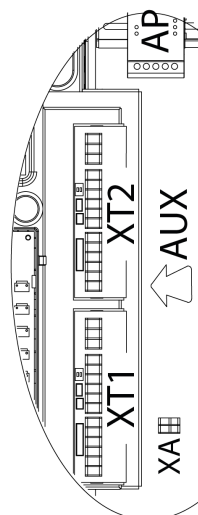
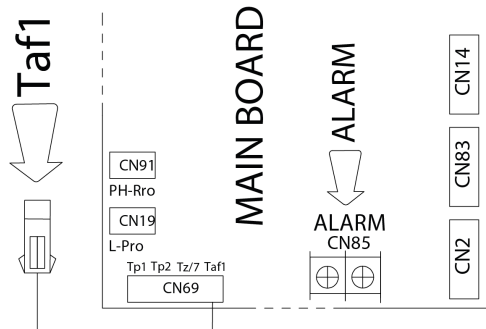

Remote control of the unit

(without PEND00017 Remote interface module for REMAUX auxiliary controls)

With S5_3 ON, the unit is controlled remotely.

Wired controller disabled.

ON/OFF state:

controlled by the On/Off input
input ON = unit ON

Heat/Cool mode:

controlled by the Heat/Cool input
On = heating, Off = Cooling

With the units in modular configuration, remote control must be applied to the master unit, which transmits it to the slave units. After having set S5_3 disconnect and reconnect the power supply to confirm the change.

Remote control of the unit

(with PEND00017 Remote interface module for REMAUX auxiliary controls)

With S5_3 in OFF, for operation see the instructions of the accessory supplied separately.

Alarm signal - ALARM

The door is closed with alarmed unit..

Functioning compressor signal - HL1

Connect the signal lamp as shown in the diagram.

External pump control - PUMP-N

In case of a unit supplied with no circulation pump, control the external pump as shown in the diagram.

Use a contactor.

Auxiliary heater control - KA-H2

Control the auxiliary heater as shown in the diagram.

Use a contactor.

Anti-freeze heater control - KA-H1

Control the heater as shown in the diagram

Use a contactor.

Modbus

Connect on the back of the controller.

Modular unit: connect the modbus to the MASTER unit port.

ON-OFF

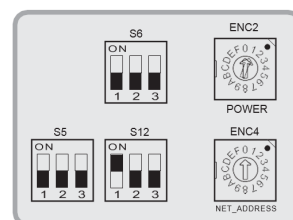
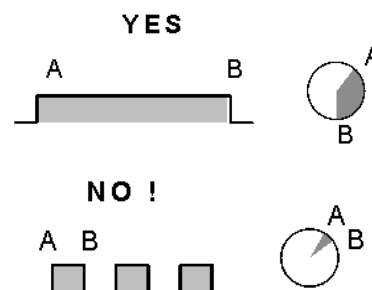

S6-3

ON = anti-snow function enabled
OFF = disable (factory setting)

MODBUS

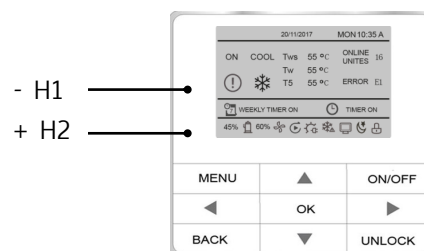

TW probe

The total system supply water control probe is installed on the supply pipe in the fan compartment. With the unit in modular configuration, the master unit's TW probe must be reinstalled on the system's common supply line, as far away as possible.

Use the additional probe trap in the electrical panel.

Keep the connection to the electrical panel, just remove the sensor that is inserted in the water supply pipe inside the trap. The probe is physically clamped by a cable gland.

Taf1 Probe

The domestic hot water antifreeze protection probe is located inside the electrical panel in a plastic bag with a 10m long cable.

To remotely control the Taf1 probe, electrically disconnect the one in the electrical panel (only 3 m long) and connect the one in the bag labelled Taf1 to the same connector.

T5 Probe

The temperature probe that switches from system to domestic hot water is located inside the electrical panel in a plastic bag with a 10m long cable. Connect it to the free connector labelled "T5" in the electrical panel.

Keypad remote connections

The keypad is wired on the unit.

It can be disassembled and installed remotely.

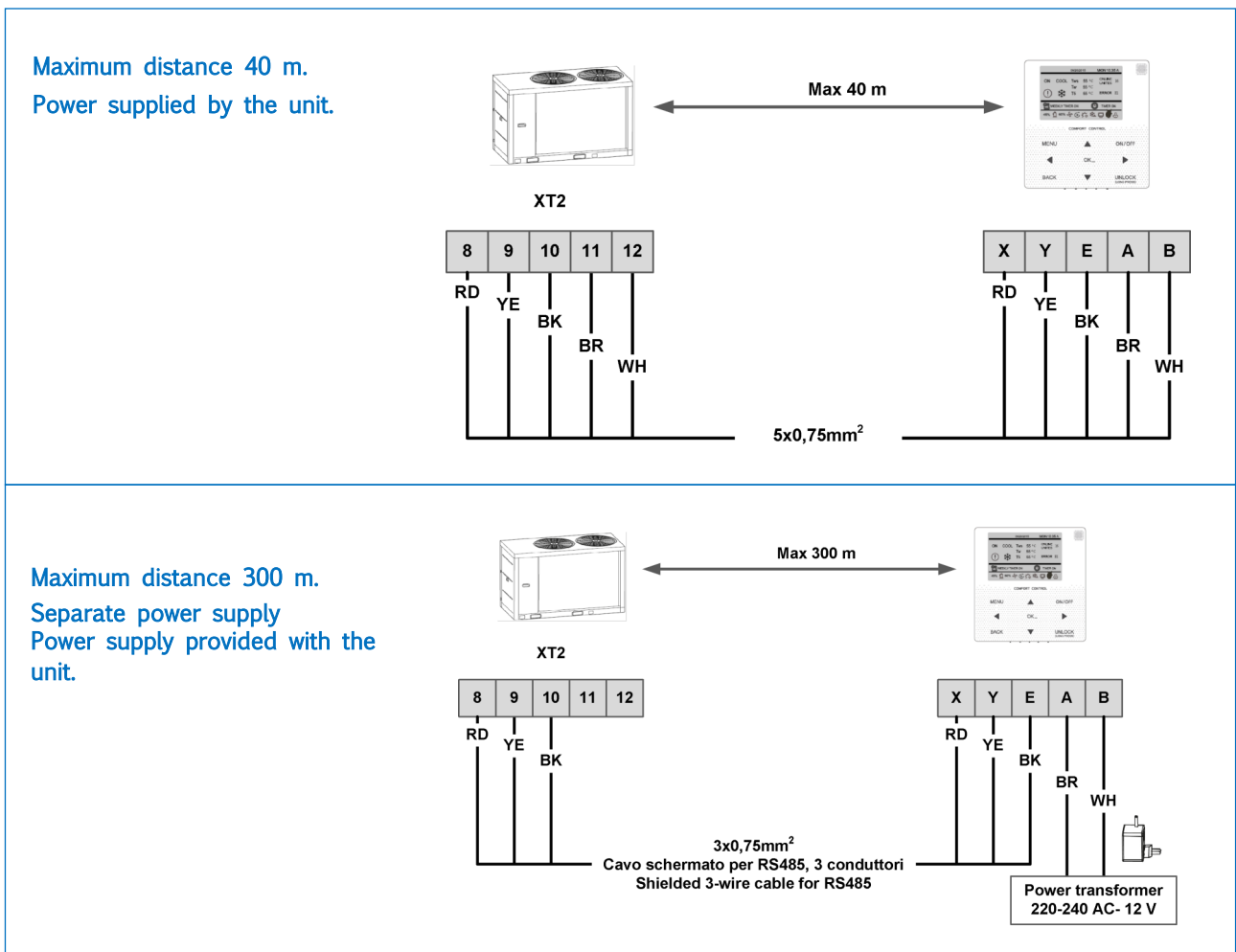

Domestic hot water

Option.

Domestic hot water management is of priority compared to the system.

In DHW production mode, the compressors start only if the DHW storage temperature is above a minimum threshold (see chart).

The maximum supply temperature threshold of the system is variable based on the outdoor temperature.

To prevent it from falling below the minimum temperature, it is advisable to install a backup electric heater on the DHW storage

The following components are required:

- 3-way valve SV1
- temperature probe Taf1
antifreeze protection for domestic hot water
- temperature probe T5
regulation and switching between system and DHW production

Operations sequence:

- 1 disconnect the probe Taf1 supplied and connected as standard on the unit (main board-CN69)
- 2 connect the probe Taf1 supplied as spare part with the 10mt cable (main board-CN69)
- 3 after connecting the cable put the probe on the domestic hot water line
- 4 connect T5 connector and put the T5 probe into the domestic hot water storage

Domestic hot water management

DHW storage

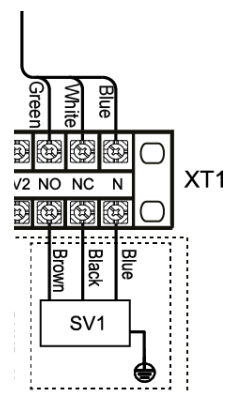
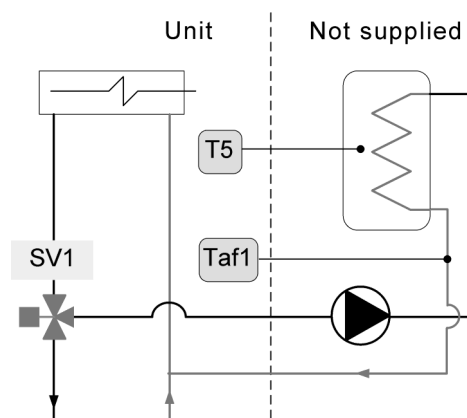

T outdoor	T5 DHW storage tanks	compr.	backup heater
24°C < t.o ≤ 30°C	< 15°C	OFF	ON
24°C < t.o ≤ 30°C	≥ 15°C	ON	OFF
t.o > 30°C	< 20°C	OFF	ON
t.o > 30°C	≥ 20°C	ON	OFF

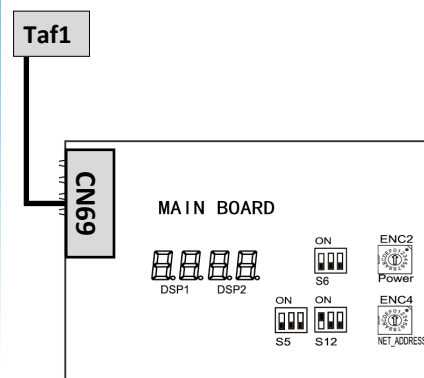

General

The indicated operations should be done by qualified technician with specific training on the product.

The electrical, water connections and the other system works are by the installer.

Upon request, the service centres performing the start-up.

Agree upon in advance the start-up data with the service centre.

For details, refer to the various chapters in the manual.

Before checking, please verify the following:

- the unit should be installed properly and in conformity with this manual
- the electrical power supply line should be sectioned at the beginning.
- The line sectionalizing device is open, locked and equipped with the suitable warning
- make sure no tension is present

WARNING

⇒ *After turning off the power, wait at least 10 minutes before accessing to the electrical panel or any other electrical component.*

⇒ *Before accessing check with a multimeter that there are no residual stresses*

⇒ *Do not power the unit with empty water side exchangers. Possible damage to anti-freeze electric heaters.*

Preliminary checks

Unit power supply OFF

		Yes / No
1	safe access	
2	suitable frame to withstand unit weight + people weight	
3	functional clearances	
4	air flow: correct return and supply (no bypass, no stratification)	
5	condensation drain	
6	considered level to be reachable by snow	
7	considered main winds	
8	lack of chimneys/corrosive atmospheres/pollutants	
9	structure integrity	
10	fans run freely	
11	unit on vibration isolators	
12	unit levelled	
13	unit input water filter + shut-off valves for cleaning	
14	vibration dampeners on hydraulic connections	
15	expansion tank (recommended volume = 10% system content)	
16	minimum system water content	
17	clean system	
18	loaded system + possible glycol solution + corrosion inhibitor	
19	system under pressure + vented	
20	refrigerant circuit visual check	
21	earthing connection	
22	power supply features	
23	connections performed by Customer: electrical connected, configuration	

Start-up sequence

Unit power supply ON

		Yes / No
1	compressor carter resistances operating at least since 8 hours	
2	off-load voltage measure	
3	phase sequence check	
4	pump manual start-up and flow check	
5	refrigeration circuit shut-off valves opening (if applicable)	
6	unit ON	
7	load voltage measure	
8	if remote On-Off: set dip-switch S5-3 on ON	
9	if units in modular configuration set dip-switch S12-2 on ON set unit address via ENC4	
10	verify the lack of bubbles in the liquid light (if applicable)	
11	check of all fan operating	
12	measure of return and supply water temperature	
13	super-heating and sub-cooling measure	
14	check no anomalous vibrations are present	
15	set-point personalization	
16	scheduling customisation	
17	complete and available unit documentation	

Cooling circuit

- 1 Visually inspect the refrigerating circuit: the presence of oil stains can be a symptom of leakage (caused e.g. by transportation, handling or other).
- 2 Verify that the refrigerating circuit is in pressure: Using the unit manometers, if present, or service manometers.
- 3 Make sure that all the service outlets are closed with proper caps; if caps are not present a leak of refrigerant can be possible.
- 4 Open all of the refrigeration circuit shut-off valves (if applicable).

Hydraulic circuit

- 1 Before connecting the unit to the hydraulic system, make sure that the hydraulic system has been washed and that the water has been drained
- 2 Check that the hydraulic circuit has been filled and pressurized-
- 3 Check that the shut-off valves in the circuit are in the "OPEN" position.
- 4 Check that there is no air inside the circuit, and bleed it through the vent valves in the high points of the system if necessary.
- 5 When using antifreeze solutions, make sure the glycol percentage is suitable for the type of use envisaged.

NOTE

⇒ *Neglecting the washing will lead to several filter cleaning interventions and at worst cases can cause damages to the exchangers and the other parts.*

Electric circuit

Check the unit is connected to the earthing system.

Check the conductors are tightened as: the vibrations caused by handling and transport might cause these to come loose.

Power the unit by closing the isolation device but leave in OFF.

Check the network frequency and voltage values, which must be within the limits: 380-415V 3N~ 50Hz +/-6%

Check and adjust the phase balance as necessary: it must be lower than 2%

Example:

$$400 - 6\% = 376$$

$$400 + 6\% = 424$$

NOTE

⇒ *Working outside of these limits can cause irreversible damages and voids the warranty.*

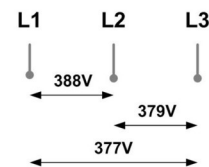

$$1) \frac{388 + 379 + 377}{3} = 381 \text{ (A)}$$

$$2) \text{MAX} - A = 388 - 381 = 7$$

$$3) S = \frac{7}{A} \times 100 = 1,83 \text{ OK}$$

Compressor casing resistances

Connect the compressor oil heating resistances at least 8 hours before the compressor is to be started:

- at the first unit start-up
 - after each prolonged period of inactivity
- 1 Power the heaters: isolator switch on 1 / ON.
 - 2 Check the power consumption of the resistances to make sure that they are functioning.
 - 3 Start-up the compressor only if the crank-case temperature on the lower side is higher than the outside temperature by at least 10°C .
 - 4 Do not start the compressor with the crankcase oil below operating temperature.

Voltage

Check that the air and water temperatures are within in the operating limits.

Start-up the unit.

While the unit is operative, i.e. in stable conditions nearing operating ones, check:

- Power supply voltage
- Total absorption of the unit
- Absorption of the single electric loads

Remote controls

Check that the remote controls (ON-OFF etc) are connected and, if necessary, enabled with the respective parameters as indicated in the “electrical connections” section.

Check that probes and optional components are connected and enabled with the respective parameters (“electrical connections” section and following pages).

Scroll compressor (only 30.2-40.2)

Scroll compressors have only one rotation direction.

In the event it is reversed, the compressor is not immediately damaged but it becomes more noisy and pumping is jeopardized.

After a few minutes, the compressor shuts down due to the thermal protection trip.

In this case, disconnect the power supply and invert 2 phases on the machine power supply.

Do not let the compressor work for a long time with opposite rotation: more than 2-3 of these abnormal start-ups can damage it.

To ensure the rotation direction is correct, measure the condensation and suction pressure.

The pressures must differ significantly: upon start-up, the suction pressure decreases while the condensation one increases.

Start-up report

To detect the objective operational conditions is useful to control the unit over time.

With unit at steady state, i.e. in stable and close-to-work conditions, identify the following data:

- total voltages and absorptions with unit at full load
- absorptions of the different electric loads (compressors, fans, pumps etc)
- temperatures and flows of the different fluids (water, air) both in input and in output from the unit
- temperatures and pressures in the feature points of the cooling circuit (compressor, liquid, suction drain/unload)

The detections must be kept and made available during maintenance interventions.

Directive 2014/68EU PED

Directive 2014/68EU PED also sets out the regulations for unit installers, users and maintenance operators.

Refer to local regulations; briefly and as an example, see the following:

Compulsory verification of the first installation:

- only for units assembled on the installer's building site (for ex. condensing circuit + direct expansion unit)

Commissioning declaration:

- for all units

Periodical checks:

- to be executed with the frequency indicated by the Manufacturer (see the "maintenance inspections" paragraph)

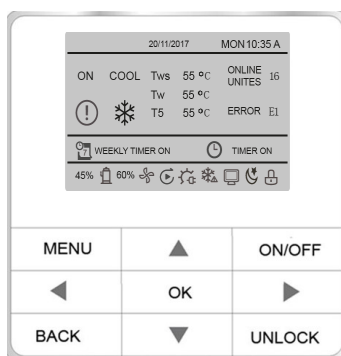

UNLOCK	To lockout / unlock.
▲ ▼	To modify current setpoint
MENU	To open the various menus from the HOME screen.
▲ ▼ ◀ ▶	To move the cursor, change the selection or change the set value. The parameter can be quickly changed with a long press.
OK	To confirm an operation.
ON/OFF	To set the ON / OFF function.
BACK	To return to the previous level. Press to exit the current page and return to the previous page. Long press to return straight to the home screen.

Units in modular configuration

On the slave controllers, only the password-protected SERVICE menu can be opened.

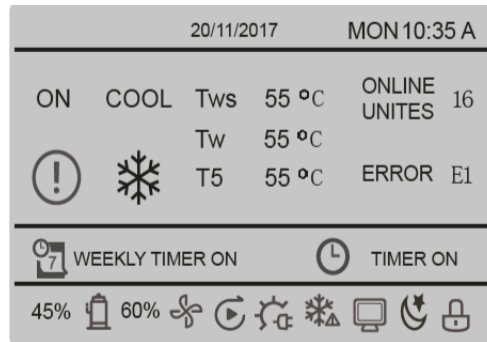

	Mode : indicate respectively heating, cooling, domestic hot water
OFF	Controller off
	Weekly timer active
45%	Compressor use value
	Compressor in operation
60%	Fan use value
	Fan in operation
	Pump in operation
	Auxiliary electric heater in operation.
	Manual antifreeze or defrosting in operation
	Remote control: the unit is set from the keypad to be controlled by a remote terminal or by a remote switch
	SILENT mode.
	Key lock
	Timer on
	Alarm: indicator on when there is a fault or a protection is tripped.

Units in modular configuration

The information displayed on ALL controllers refers to the MASTER unit.

MENU

MODE
 USER MENU
 PROJECT MENU
 SERVICE MENU

MODE

HEAT
 COOL
 DHW

USER MENU

QUERY
 TIMER
 SILENT MODE
 DOUBLE SETPOINT
 TEMPERATURE COMPENSATION
 SNOW-BLOWING SWITCH
 HEATER CONTROL
 DHW SWITCH

QUERY

STATE QUERY
 OPERATION STATE
 RUNNING MODE
 CURRENT SILENT MODE
 TEMP QUERY
 IN-LET WATER TEMP
 OUT-LET WATER TEMP
 TOTAL OUT-LET WATER TEMP
 AMBIENT TEMP

TIMER

DAILY TIMER
 WEEKLY SCHEDULE
 DATE AND TIME

SILENT MODE

STANDARD MODE
 SILENTE MODE
 SUPER SILENT MODE

DOUBLE SETPOINT

ENABLE - DISABLE

TEMPERATURE COMPENSATION

COOL MODE
 HEAT MODE

SNOW-BLOWING SWITCH

YES - NO

HEATER CONTROL

YES - NO

DHW SWITCH

YES - NO

PROJECT MENU *

SET UNIT AIR-CONDITIONING
 SET PARALLEL UNIT
 SET UNIT PROTECTION
 SET DEFROSTING
 SET HEATER
 CHECS PARTS
 CONTROLLER SELECT
 PUMP CONVERTER CONTROL

SERVICE MENU *

STATE QUERY
 HISTORY ERRORS QUERY
 MANUAL DEFROST
 PUMP MANUAL SWITCH

*** for Service Centers only**

Unlock/lock

To lockout the screen, press UNLOCK for 3 sec.

Switch-on/off

Press ON/OFF to switch-on/off

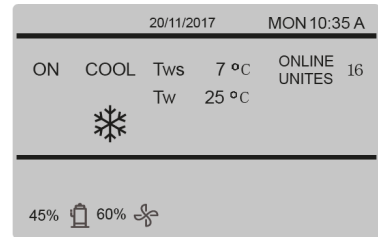

Units in modular configuration

On the slave controllers, only the password-protected SERVICE menu can be opened.

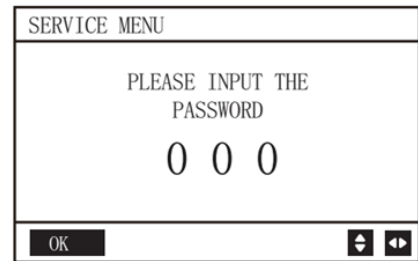

Set MODE and TEMPERATURE

Press MENU

Press ▲ or ▼ to select MODE

Press OK

Press ◀ or ▶ to select the mode or the temperature

Press ▲ or ▼ to adjust the mode and temperature.

Press OK to confirm.

If no operations are performed for more than 60 seconds, the system automatically saves the settings and returns to the home page.

Note

During cooling with T ext < 15°C, the setpoint is forced to 10 °C (ref. Functioning limits)

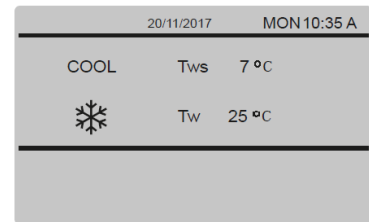
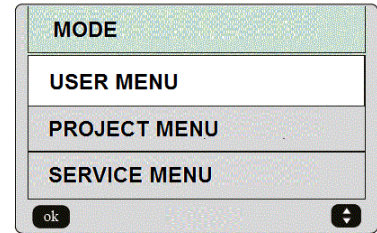

DOMESTIC HOT WATER

The ACS, if present and enabled, must be activated.

Press MENU

Press ▲ or ▼ to select MODE

Press OK

Press t or u to select the DHW mode

Press On-Off

Press OK to confirm.

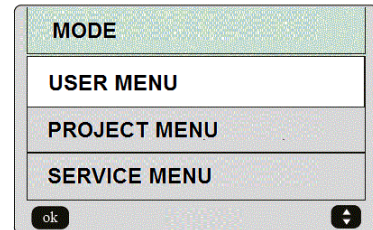

USER MENU

Press MENU

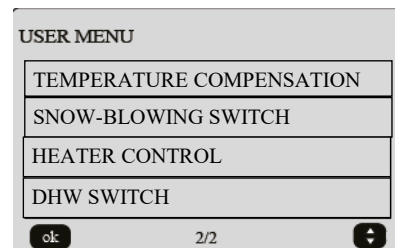
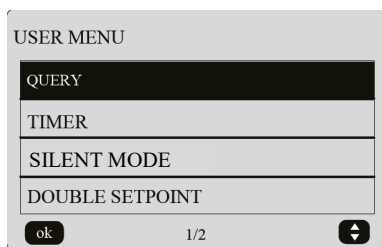

USER MENU - QUERY

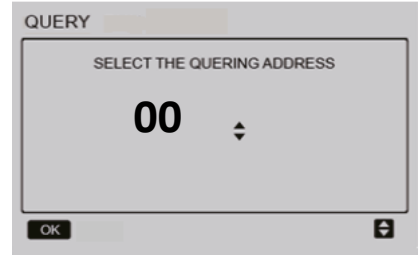

Only if multiple units are connected to the network

To display data for the units in the network:

Press MENU

Press ▲ or ▼ to select QUERY

Press ◀ or ▶ to select the unit's address

Press OK

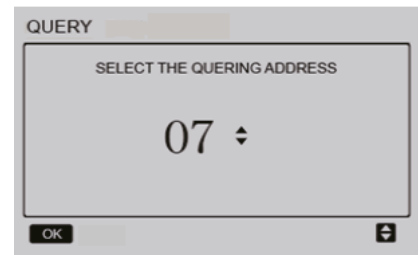

If STATE QUERY is selected:the unit's address is shown at top right (only for units in modular configuration)

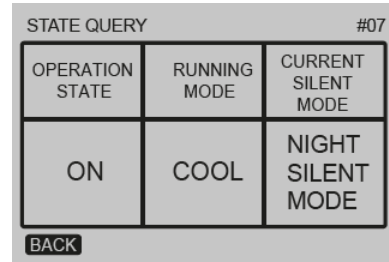
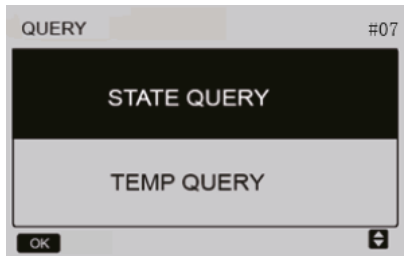

If TEMP QUERY is selected:

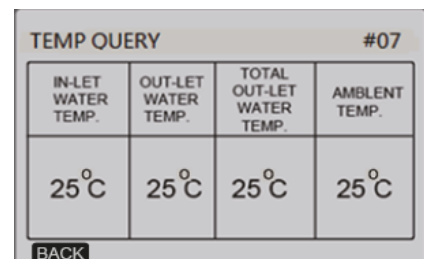

USER MENU - TIMER

Press MENU

Press TIMER

Select one of the 3 categories proposed

If “DAILY TIMER” is selected, the “WEEKLY SCHEDULE” cannot be activated and vice versa.

If the unit is controlled via a remote On-Off or Modbus, DAILY and WEEKLY timers are disabled.

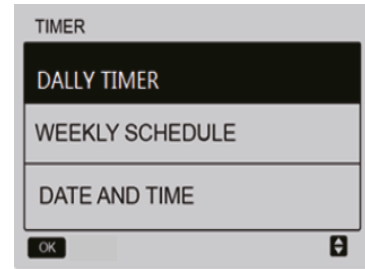

TIMER menu - DAILY TIMER

Press ▲ or ▼ to select timer 1 or timer 2

Press ON/OFF when the cursor is over the word ACT

Press ◀ or ▶ to select the starting time, the end time and the mode

Press ▲ or ▼ to select the time, mode, temperature, silent mode

Press ◀ or ▶ to set the silent, standard, night silent or super silent modes

Press OK to confirm

The “🕒 Timer on” symbol appears on the main screen

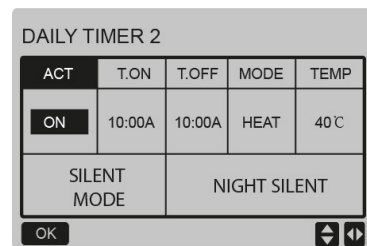
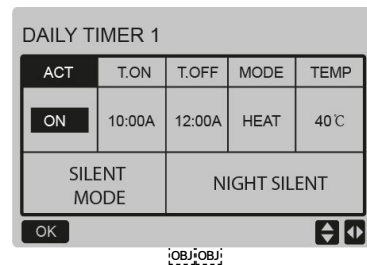

If two time slots overlap, the last one on the lists is activated (in figure OFF)

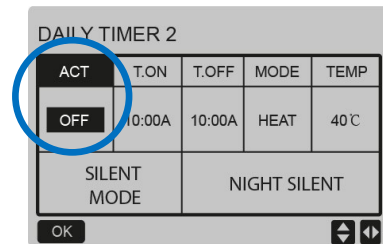

TIMER menu - WEEKLY TIMER

Select WEEKLY SCHEDULE
 Press ▲ or ▼ to select the day
 Set ON or OFF
 Press OK to confirm

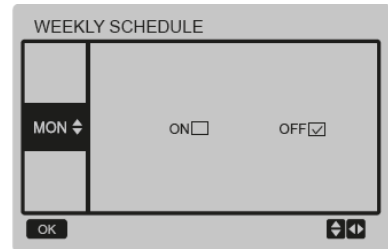

Press ◀ or ▶ to select timer 1 or timer 2
 Press ON/OFF when the cursor is over the word ACT
 Press ◀ or ▶ to select the starting time, the end time and the mode
 Press ▲ or ▼ to select the time, mode, temperature, silent mode
 Press ◀ or ▶ to set the silent, standard, night silent or super silent modes
 Press OK to confirm
 The “📅 Weekly timer on” symbol appears on the main screen

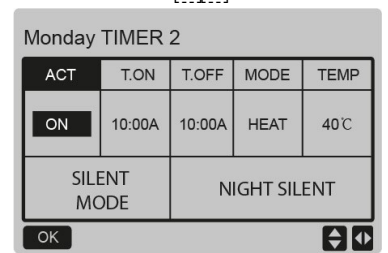
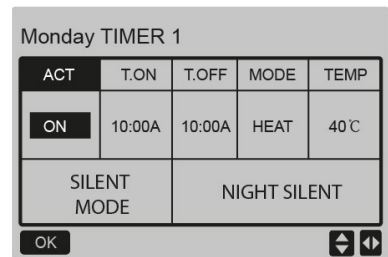

TIMER menu - DATE and TIME

Select DATE AND TIME
 Select DATE to change the date
 Select TIME to change the time

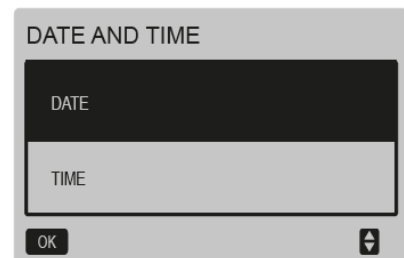

USER menu - SILENT MODE SWITCH

Press ◀ or ▶ to select the mode:
 Standard, Silent, Supersilent
 Press OK to save the settings

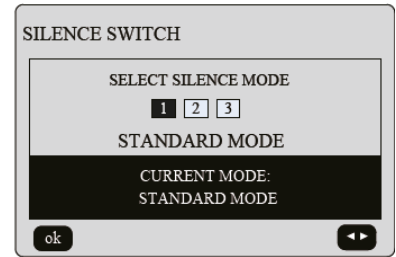

USER menu - DOUBLE SETPOINT

Press ▲ or ▼ to ENABLE or DISABLE.

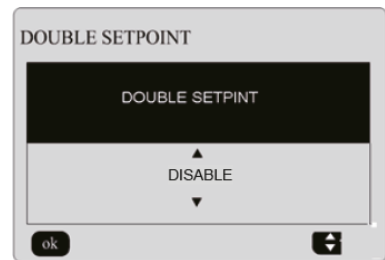

Enable the double setpoint

Press ◀ or ▶ to select the setpoint mode
 Press ▲ or ▼ to adjust the parameters

The 2nd setpoint is activated only if the “temp-switch” input on the terminal block XT2 is closed

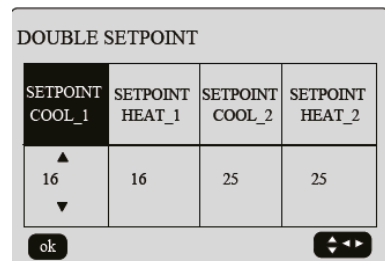

USER menu - TEMPERATURE COMPENSATION

Press ▲ or ▼ to select:

COOL MODE

HEAT MODE

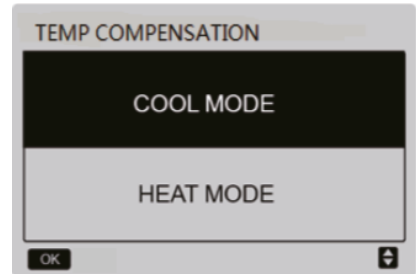

The water temperature is adjusted based on the outdoor temperature T4.

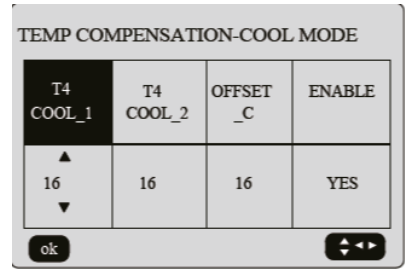

COOLING

The following parameters can be adjusted:

- T4_cool_1 (25~30°C)
- T4_cool_2 (30~40°C)
- offset_c (0~15°C)

HEATING

The following parameters can be adjusted:

- T4_heat_1 (0~5°C)
- T4_heat_2 (15~20°C)
- offset_h (0~15°C)

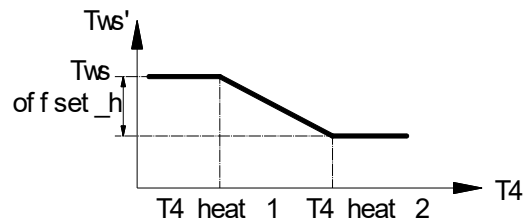
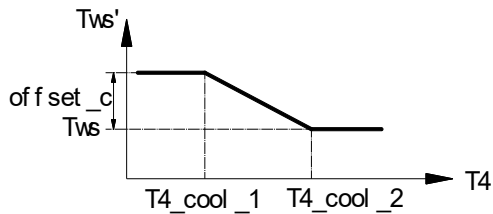



menu USER - SNOW-BLOWING SWITCH

If enabled, the function activates the fans in order to avoid the accumulation of snow.

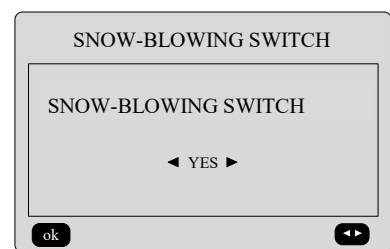
The fans start for 2 minutes every 30 minutes. With T air < 3°C and unit stopped.

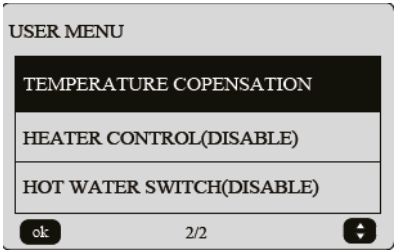
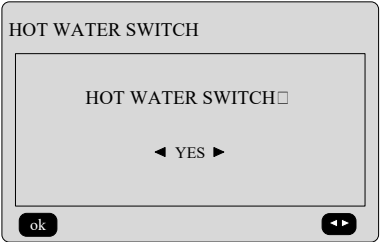
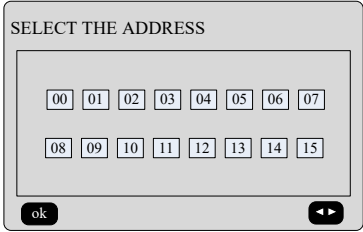
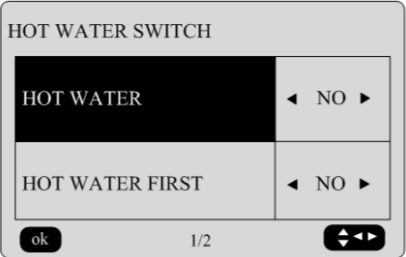
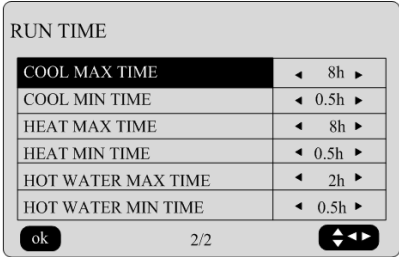

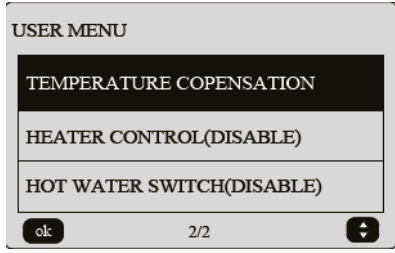
<p>USER MENU - DOMESTIC HOT WATER Select HOT WATER</p>	
<p>single unit</p>	
<p>units in modular configuration select address</p>	
<p>enable domestic hot water, if applicable activate priority of domestic hot water, if applicable</p>	
<p>minimum and maximum operating times of the unit once it has entered the corresponding mode</p>	

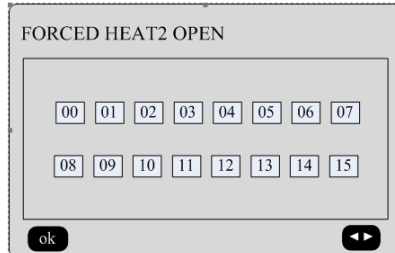
<p>USER MENU - AUXILIARY HEATER domestic hot water storage (wiring diagram: KA-H2) select heater control</p>	
	
<p>single unit</p>	
<p>units in modular configuration select address</p>	

STATUSES DISPLAY

If the keyboard is remote, it is possible to read the unit statuses also from the display on the main board.

Press UP on the main board.

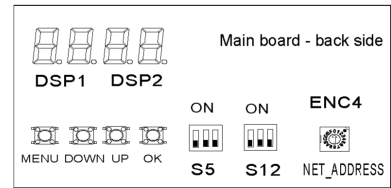

	Standby: unit address (88 to the left) + online number (88 to the right) On: frequency defrosting: dFdF
0.xx	unit address
1.xx	high pressure
2.xx	number of units
3.xx	T4 correction
4.xx	Mode (8: Off; 0: Standby; 1: Cooling; 2: Heating)
5.xx	fan speed 1
6.xx	fan speed 2
7.xx	T3: coil temperature
8.xx	T4: outside temperature
9.xx	T5: DHW temperature:
10.xx	Taf1: exchanger outlet temperature, antifreeze protection
11.xx	Taf2: exchanger outlet temperature, antifreeze protection
12.xx	Tw: common outlet water temperature, after the last unit
t.xx	Tw inlet water
14.xx	Two outlet water
15.xx	Tz total outlet water
16.xx	THeatR recovery
17.xx	supply 1
18.xx	supply 2
19.xx	Radiation fin temperature 1
20.xx	Radiation fin temperature 2
21.xx	saturated drain temperature (+25)
22.xx	Compressor current A
23.xx	Compressor current B
24.xx	Pump current
25.xx	electronic expansion valve opening A (/20)

26.xx	electronic expansion valve opening B (/20)
27.xx	electronic expansion valve opening C (/4)
28.xx	high pressure
L.xx	low pressure
30.xx	overheating
31.xx	intake temperature
32.xx	silent
33.xx	static pressure
34.xx	DC voltage A (reserved)
35.xx	DC voltage B (reserved)
36.xx	frequency limit (0 = None; 1 = T4 ; 2 = pressure; 3 = drain; 4 = low pressure ratio; 5 = Real-time ; 6 = Current frequency ; 7: = voltage; 8: Adjustment of energy requirement of pressure ratio ; 9 = low pressure in cooling)
37.xx	defrosting status (1st digit: T4 selection solution; 2nd digit: at intervals ; 3rd and 4th digit
38.xx	EPROM error: 1: Error; 0: No error
39.xx	defrosting
40.xx	initial frequency
41.xx	Tc: Saturation temperature corresponding to high pressure in heating mode
42.xx	Te: Saturation temperature corresponding to low pressure in cooling mode
43.xx	T6a: exchanger inlet temperature
44.xx	T6b: exchanger outlet temperature
45.xx	software version
46.xx	last error
47.xx	----

Alarm reset: turn the unit off and on again.

NOTE

⇒ *Before resetting an alarm, identify and remove the cause generating that.*

⇒ *Repeated resets can cause irreversible damage.*

Master unit

If the Master unit's power supply is disconnected, all of the group's units stop.

- The unit is in protection in the following conditions:
- High pressure or protection due to drain temperature
- low voltage
- compressor current protection
- frequency protection of the inverter compressor
- condenser high temperature
- high temperature difference between the input and output water
- antifreeze protection
- drain temperature sensor malfunction
- low evaporator temperature
- frequency protection by voltage
- compressor inverter malfunction
- fan motor protection
- water return high temperature, in cooling
- low pressure antifreeze protection
- high temperature of inverter compressor module

When the unit fails or is in protection, the water pump continues working (except for water flow alarm, voltage protection, phase sequence protection).

When the master unit is in protection, only the master unit stops and the other units carry on working.

When a slave unit is in protection, this unit stops and the other units are not involved.

If the master unit fails, the slave units also stop working.

Temperature sensors

All temperature sensors are classed as faulty when the voltage on the corresponding input is lower than 0.05 V or higher than 4.95 V.

After an error has been signalled, all units stop. The error is eliminated after the sensor has been restored.

Error code	Description
1E0	EEPROM error - main board
2E0	EEPROM error - inverter A module
3E0	EEPROM error - inverter B module
E1	phases sequence - control from main board
E2	communication error between main board and keypad
E3	“Total” outlet water temperature probe Tw fault (only for master unit)
E4	outlet water temperature probe Two fault
1E5	condenser temperature probe T3A fault
2E5	condenser temperature probe T3B fault
E6	storage temperature probe T5 fault
E7	room temperature probe T4 fault
E8	phases sequence
E9	no flow (manual reset) Ddained system
1Eb	antifreeze probe Taf1 fault
2Eb	antifreeze probe Taf2 fault
EC	Slave unit module reduction
1Ed	compressor drain temperature probe A
2Ed	compressor drain temperature probe B
1EE	refrigerant temperature probe T6A
2EE	refrigerant temperature probe T6B
EF	return water temperature probe
EH	autotest error
EP	drain temperature probe
EU	condenser total temperature probe Tz
P0	high pressure / drain temperature
P1	low pressure
P2	total condenser output high temperature Tz
P4	compressor A in protection
P6	module error
P7	condenser high temperature
P8	Reserved

P9	Inlet / outlet water temperature difference
PA	Reserved
Pb	winter antifreeze
PC	evaporator low pressure in cooling
PE	antifreeze protection evaporator low temperature in cooling
PF	circuit board lock - controller lock/unlock error
PH	high room temperature probe T4
PL	Tfin module, high temperature
1PP	IPM module error, circuit A
2PP	IPM module error, circuit B
1PU	fan A module
2PU	fan B module
3PU	fan C module
1H9	compressor driver A - configuration error
2H9	compressor driver B - configuration error
H5	High / low voltage
1HE	valve A error
2HE	valve B error
3HE	valve C error
1F0	IPM module transmission error
2F0	IPM module transmission error
F2	insufficient overheating
1F3	Fan A transmission error
2F3	Fan B transmission error
3F3	Fan C transmission error
1F4	protection L0 or L1 intervention 3 times in 60 minutes
2F4	protection L0 or L1 intervention 3 times in 60 minutes
1F6	circuit A bus voltage (PTC)
2F6	circuit B bus voltage (PTC)
F7	Reserved
1F9	radiator temperature sensor Tfin1

2F9	radiator temperature sensor Tfin2
1FA	Reserved
2FA	Reserved
Fb	pressure sensor
Fd	return air temperature sensor
FE	recovery temperature sensor
1FF	fan A
2FF	fan B
3FF	fan C
FP	DIP switch for modular unit configuration error
C7	3 times PL
L0	module protection
L1	low voltage
L2	high voltage
L4	MCE error
L5	speed 0
L7	no phase
L8	variation of frequency higher than 15Hz
L9	difference of phase frequency higher than 15Hz
d0	Gate error (d0 and address alternatively displayed every 10 sec)
dF	defrosting

Area checks

Before working on systems containing flammable refrigerants, perform safety checks to reduce the risk of combustion to the minimum. Before performing any reparation operations on the cooling system, comply with the following warnings.

Work procedures

Operations must be performed following a controlled procedure so as to reduce the risk of flammable gases or vapours developing.

General work area

All the personnel in charge with maintenance operations and other operators working in the local area must be instructed and monitored as regards the nature of the intervention.

Avoid working in tight spaces. The area surrounding the working space must be cordoned off. Make sure the area is secured by monitoring the flammable material.

Check the presence of refrigerant

Both before and during operations, the area must be monitored with a dedicated refrigerant detector to make sure the technician is aware of the presence of potentially-flammable environments.

Make sure the leak detection equipment is suitable for use with flammable refrigerants and therefore without sparks, suitably sealed or intrinsically safe.

Presence of the fire extinguisher

If hot interventions are not performed on cooling equipment or connected components, suitable fire fighting equipment must be kept at hand.

Keep a dry-powder or CO₂ extinguisher near the loading area.

No ignition source

It is absolutely forbidden to use ignition sources that may lead to fire or explosion during operations on the cooling system or on pipes that contain or have contained flammable refrigerant.

All possible ignition sources, including cigarettes, must be kept sufficiently away from the installation, reparation, removal and disposal site as flammable refrigerant may be released in the surrounding area.

Before starting operations, the area surrounding the equipment must be inspected to guarantee the absence of flammables or combustion risks.

“SMOKING IS FORBIDDEN” signs must be affixed.

Ventilated area

Before intervening on the system or performing any hot intervention, make sure to be in an outdoor or suitably ventilated area.

Ventilation must be maintained during operations. Ventilation must disperse the released refrigerant safely, preferably outdoors in the atmosphere.

Cooling equipment checks

Should a replacement be necessary, the new components installed must be suitable for the purpose envisaged and compliant with specifications.

Always follow the manufacturer guidelines on maintenance and assistance. In case of doubt, contact the manufacturer technical office for assistance.

The following checks must be performed on systems containing flammable refrigerants:

- the quantity of the charge must comply with the size of the room where the parts containing refrigerant are installed;
- the machine and ventilation intake function correctly and are not obstructed;
- If an indirect cooling circuit is used, the secondary circuits must be checked to verify the presence of refrigerants; the marking on the equipment remains visible and readable;
- Make sure markings and symbols are always readable; cooling pipes or components must be installed in a position that makes improbable their exposure to substances that may corrode the components containing refrigerant, unless they are manufactured with material intrinsically resistant to corrosion or suitably protected against corrosion.

Electrical device checks

The reparation and maintenance of electric components must include initial safety checks and component inspection procedures.

In case of a fault that compromises safety, do not perform any electrical connection to the circuit until said fault is suitably resolved.

If it is not possible to repair the fault immediately and electrical components need to remain functioning, a temporary solution must be adopted.

This must be reported to the owner of the equipment so as to keep all parties informed.

Initial safety checks must include:

- that condensers are emptied. This operation must be performed safely to avoid any sparks;
- that electrical components and wiring are not exposed during the charging, recovering or venting phases;
- That the earth conductor is continuous.

Repairing sealed components

- During the reparation operations of sealed components, disconnect all the equipment before removing sealed casings etc. If, during operations, it is absolutely necessary for the equipment to remain connected, a leak detection device must be placed in the most critical point so as to report any potentially-dangerous situation.
- Pay particular attention to what follows to guarantee that, while intervening on electrical components, the housing is not altered in a way so as to affect the level of protection. This includes damage to cables, an excessive number of connections, terminals not compliance with the original specifications, damage to gaskets, an unsuitable installation of gaskets, etc.
- Make sure the device is installed safely.
- Check that the seals or sealing materials are not altered in such a way that they no longer impede the entry of flammable environments. Spare parts must comply with manufacturer specifications.

NOTE:

⇒ *Using silicone sealants may inhibit the effectiveness of a few types of leak detection equipment. It is not necessary to isolate intrinsically safe components before performing operations on them.*

Reparation of intrinsically safe components

Do not apply permanent inductive or capacitive loads to the circuit without making sure that they do not exceed the admissible voltage and current allowed for equipment in use.

Intrinsically safe components are the only component type on which operations can be performed in a flammable atmosphere. The testing device must show a correct value. Replace components only with the parts specified by the manufacturer.

Following a leak, other parts could lead to the combustion of the refrigerant in the atmosphere.

Wires

Make sure wires are not subjected to wear, corrosion, excessive pressure or vibration, that there are no sharp edges and that they do not produce other negative effects on the environment. The inspection must also keep into consideration the effects of time or the continuous vibration caused e.g. by compressors or fans.

Detection of flammable refrigerants

Under no circumstance is it possible to use potential ignition sources to search or detect refrigerant leaks. Do not use halide lights (or any other open flame detectors).

Leak detection methods

The following leak detection methods are considered acceptable for systems containing flammable refrigerants. Electric leak detectors must always be used to identify flammable refrigerants, although they do not present a suitable sensitivity level or require recalibration (detection equipment must be calibrated in an area free from refrigerants).

Check that the detector is not a possible source of ignition and that it is suitable for the refrigerant. Leak detection equipment must always be set to an LFL percentage and calibrated depending on the refrigerant used, so the correct gas percentage (25% max) must be verified.

Leak detection fluids are suitable for most refrigerants, although using detergents containing chlorine should be avoided as this substance may react with the refrigerant and corrode copper pipes.

If a leak is suspected, all open flames must be removed or switched off.

If a leak is identified that requires brazing, all the refrigerant must be recovered from the system or isolated (using interception valves) in a section of the system far away from the leak. Oxygen-Free-Nitrogen (OFN) is then purged through the system both before and during the brazing procedure.

Removal and evacuation

When intervening on the cooling circuit to perform repair work or any other type of work, always follow the normal procedure. However, considering the risk of flammability, we recommend following the best practices. Comply with the following procedure:

- remove the refrigerant;
- purge the circuit with inert gas;
- evacuate;
- Purge again with inert gas;
- Interrupt the circuit with interruption or brazing.

The refrigerant charge must be collected in suitable recovery tanks. To make the unit safe, flushing with Oxygen-free-Nitrogen must be performed. This procedure may have to be repeated multiple times. Do not use compressed air or oxygen for this operation.

Flushing is obtained interrupting the system vacuum with OFN and filling until the operating pressure is obtained, then releasing into the atmosphere and restoring the vacuum. This process must be repeated until there is no trace of refrigerant in the system.

When using the final OFN charge, the system must be vented to the atmospheric pressure to allow the intervention. This step is essential to perform brazing operations on the pipes.

Make sure that the vacuum pump intake is not near ignition sources and that there is suitable ventilation.

Charging operations

In addition to conventional charging operations, the following requirements must be complied with:

- When using charging equipment, make sure that the various refrigerants are not contaminated. Flexible tubes or conduits must be as short as possible to reduce to the minimum the quantity of refrigerant contained.
- Tanks must be kept in a vertical position.
- Before loading the system with refrigerant, check that the cooling system is earthed.
- Label the system when fully charged (unless already labelled).
- Make sure not to fill the cooling system excessively.
- Before recharging the system, the pressure must be tested with OFN. A leak test must be performed after the charging operations but before commissioning. Before leaving the site, perform an additional leak test.

Dismantling

Before performing this procedure, it is essential that the technician has become familiar with the equipment and the relative details.

We recommend employing good practices for a safe recovery of the refrigerants.

Before performing the operation, take a sample of oil and refrigerant should an analysis be necessary before reusing the regenerated refrigerant. Before performing the operation, check the availability of electricity.

- Become familiar with the equipment and how it functions.
- Electrically isolate the system.

Before attempting the procedure, check that:

- The mechanical manipulation equipment is available, if necessary, to handle refrigerant tanks;
- All the personal protection equipment is available and employed correctly;
- The recovery procedure is monitored at all times by skilled personnel;
- The recovery equipment and tanks comply with suitable standards.
- If possible, pump the cooling system.
- If it is not possible to obtain a vacuum, make sure that a collector removes the refrigerant from various parts of the system.
- Before proceeding with the recovery, check that the tank is located on the scales.
- Start up the recovery machine and use it following the instructions by the manufacturer.
- Do not fill the tanks excessively. (Do not exceed 80% of the liquid volume).
- Do not exceed the tank's maximum operating pressure, not even momentarily.
- Once the tanks are filled correctly and the process is over, make sure that the tanks and equipment are immediately removed from the site and that all insulation valves on the equipment are closed.
- The refrigerant recovered must not be loaded into another cooling system unless it has been cleaned and checked.

Labelling

Equipment must be labelled reporting the dismantling and emptying of the refrigerant.

Labels must be dated and signed.

Make sure all the equipment is labelled and reporting the presence of flammable refrigerant.

Recovery

When removing the refrigerant from the system, please adopt good practices to remove all refrigerants safely in case of both assistance or decommissioning operations.

When transferring the refrigerant into the tanks, make sure only suitable tanks are used to recover the refrigerant.

Make sure enough tanks are used.

All the tanks to be used are designated for the recovered refrigerant and are labelled for that specific refrigerant (e.g. special tanks for refrigerant collection).

Tanks must be equipped with a perfectly-functioning safety valve and relative interception valves.

Empty recovery tanks are evacuated and, if possible, cooled before recovery.

Recovery equipment must be perfectly functioning with the respective instruction booklets at hand and they must be suitable to recover flammable refrigerants. A series of perfectly-functioning calibrated scales must also be available.

Flexible tubes must be equipped with leak-proof disconnection fittings in good condition. Before using the recovery machine, make sure it is in good condition, maintained and that all associated electrical components are sealed to avoid combustion in case of a refrigerant leak. Please contact the manufacturer in case of doubt.

The refrigerant recovered must be taken to the supplier in suitable recovery tanks and with the relative waste transfer note suitably filled in.

Do not mix the refrigerants in the recovery units nor in the tanks.

If it is necessary to remove compressors or compressor oils, make sure they are evacuated to an acceptable level to make sure no trace is left of the flammable refrigerant inside the lubricant. The evacuation process must be performed before taking the compressors back to the suppliers.

The electric resistance must be used with the compressor body only to accelerate this process.

Operations to discharge the oil from the system must be performed in full safety.

Transport, mark and storage

- 1 Transport of equipment containing flammable refrigerants
Compliance with transport regulations
- 2 Marking of equipment with symbols
Compliance with local regulations
- 3 Disposal of equipment employing flammable refrigerants
Compliance with national regulations
- 4 Storage of equipment/devices
The equipment must be stored in compliance with the instructions provided by the manufacturer.
- 5 Storing packed (unsold) equipment
Packing must be performed in such a way that mechanical damage to the equipment inside it does not cause refrigerant leaks.
The maximum number of elements that can be stored together is determined by local regulations.

Safety

Operate in compliance with safety regulations in force.

To carry out the operations use protection devices:

gloves, goggles, helmet, headphones, protective knee pads.

All operations must be carried out by personnel trained on possible risks of a general nature, electrical and deriving from operating with equipment under pressure.

Only qualified personnel can operate on the unit, as required by the regulation in force.

General

Maintenance must be performed by authorized centres or by qualified personnel

The maintenance allows to:

- maintaining the unit efficient
- reduce the deterioration speed all the equipment is subject to over time
- collect information and data to understand the efficiency state of the unit and prevent possible faults

WARNING

⇒ *Before checking, please verify the following:*

⇒ *the electrical power supply line should be isolated at the beginning*

⇒ *the line isolator device is open, locked and equipped with the suitable warning sign*

⇒ *make sure no tension is present*

⇒ *After switching the power off, wait at least 10 minutes before accessing to the electrical panel or any other electrical component.*

⇒ *Before accessing check with a multimeter that there are no residual stresses.*

Frequency of interventions

Perform an inspection every 6 months.

However, frequency depends on the type of use.

Pan inspections at close intervals in the event of:

- frequent use (continuous or very intermittent use, near the operating limits, etc)
- critical use (service necessary)

WARNING

⇒ *Before any work read: Chapter. SAFETY WARNINGS FOR OPERATIONS ON UNITS CONTAINING R32*



Do not go up to the surface

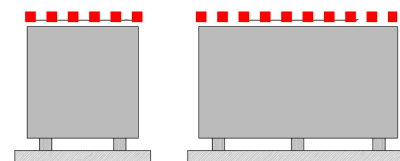

	intervention frequency (months)	1	6	12
1	Presence of corrosions			X
2	Panel fixing			X
3	Fan fixing		X	
4	coil cleaning		X	
5	Water filter cleaning		X	
6	water: quality, pH, glycol concentration		X	
7	check exchanger efficiency			X
8	circulation pump		X	
9	Check of the fixing and the insulation of the power lead			X
10	earth cable check			X
11	Electric panel cleaning			X
12	power remote controls status			X
13	clamp closure, cable isolation integrity			X
14	Voltage and phase unbalancing (no load and on-load)		X	
15	Absorptions of the single electrical loads		X	
16	compressor casing heaters test		X	
17	Checking for leaks *			*
18	cooling circuit work parameter detection		X	
19	safety valve *			*
20	protective device test: pressure switches, thermostats, flow switches etc..			X
21	control system test: setpoint, climatic compensations, capacity stepping, air flow-rate			X
22	Control device test: alarm signalling, thermometers, probes, pressure gauges etc			X

NOTE

⇒ Refer to the local regulations. Companies and technicians performing installation, maintenance/repair, leak control and recovery operations must be CERTIFIED as set out by the local regulations.

Unit booklet

Foresee a unit schedule to keep trace of the interventions made on the unit.

In this way, it will be easier to adequately schedule the various interventions and facilitate any troubleshooting.

On the schedule note:

- date
- intervention description
- carried out measures etc.

Standby mode

If foreseen a long period of inactivity:

- turn off the power
- Prevent the risk of freezing (use glycol or empty the system) disconnect voltage to avoid electric risks or damages following lightning

With lower temperatures keep heaters turned on in of the electrical panel (option).

It is recommended to have a qualified technician start the system after a period of inactivity, especially after seasonal stops or for seasonal switch-overs.

When starting, follow the instructions in the “start-up” section. Schedule technical assistance in advance to avoid hitches and to guarantee that the system can be used when required.

System drain

The system must be drained only if necessary.

Avoid draining the system periodically; corrosive phenomena can be generated.

- 1 empty the system
- 2 empty the exchanger, use all shut-off valves and grub screws
- 3 blow the exchanger with compressed air
- 4 dry the exchanger with hot air; for greater safety, fill the exchanger with glycol solution
- 5 protect the exchanger from air
- 6 take the drain caps off the pumps

Any anti-freeze liquid contained in the system should not be discharged freely as it is a pollutant. It must be collected and reused.

Before start-up, wash the system.

It is recommended to have a qualified technician start the system after a period of inactivity, especially after seasonal stops

or for seasonal switch-overs.

When starting, follow the instructions in the “start-up” section. Schedule technical assistance in advance to avoid hitches and to guarantee that the system can be used when required.

Water side heat exchanger

The exchanger must be able to provide the maximum thermal exchange, therefore it is essential for the inner surfaces to be clean of dirt and build-up.

Periodically check the difference between the temperature of the supply water and the condensation temperature: if the difference is greater than 8°C-10°C it is advisable to clean the exchanger.

The clearing must be effected:

- with circulation opposite to the usual one
- with a speed at least 1,5 times higher than the nominal one
- with an appropriate product moderately acid (95% water + 5% phosphoric acid)
- after the cleaning rinse with water to inhibit the action of any residual product

Water filter

Check that no impurities prevent the correct passage of water.

Flow switch

- controls the operations
- remove incrustations from the palette

Circulation pumps

Check:

- no leaks
- Bearing status (anomalies are highlighted by abnormal noise and vibration)
- The closing of terminal covers and the correct positioning of the cable glands.

Insulations

Check the condition of the insulations: if necessary, apply glue and renew the seals.

Safety valve

The pressure relief valve must be replaced :

- if it has intervened
- if there is oxidation
- based on the date of manufacture, in compliance with local regulations.

Air coil

⇒ *Accidental contact with the exchanger fins can cause cuts: wear protective gloves.*

The coil must allow maximum thermal exchange, therefore, the surface must be clear from dirt and scaling.

It is recommended a quarterly cleaning of the coils, as the minimum.

The cleaning frequency should be increased depending on the level of dirt/dust accumulation and the environment (e.g., coastal areas with chlorides and salts) or industrial areas with aggressive substances.

Shut down periods

During periods when the unit is not operated for longer than a week, the coil must be completely cleaned following the cleaning procedure. .

Cleaning procedure

Relative to tube & fin heat exchangers, these coils tend to accumulate more dirt on the surface of the coil and less dirt inside the coil, making them easier to clean.

Follow the steps below for proper cleaning.

Remove surface debris

Remove surface dirt, leaves, fibers, etc. with a vacuum cleaner (preferably with a brush or other soft attachment rather than a metal tube), compressed air blown from the inside out, and/or a soft bristle (not wire!) brush. Do not impact or scrape the coil.

Rinse

Rinse only with water. Do not use any chemicals to clean heat exchangers, as they may cause corrosion.

Hose off gently, preferably from the inside-out and top to bottom, running the water through every fin passage until it comes out clean.

The fins are stronger than other coil fins but still need to be handled with care. Do not hit the coil with the hose.

We do not recommend using a pressure washer to clean the coil due to the possibility of damage. Warranty claims related to cleaning damage, especially from pressure washers, or corrosion resulting from chemical coil cleaners, will NOT be honored.

Blow dry

MicroChannel heat exchangers could possibly retain more water compared to traditional tube & fin coils. It is advised to blow off or vacuum out the residual water from the coil to speed up drying and prevent pooling.

WARNING

Field applied coatings are not recommended for brazed aluminum MicroChannel heat exchangers.

Disconnection

WARNING

⇒ Before performing any operation, read the warnings found in the Maintenance chapter.

Avoid leak or spills into the environment.

Before disconnecting the unit, the following must be recovered, if present:

- refrigerant gas
- Anti-freeze solutions in the hydraulic circuit

Awaiting decommissioning and disposal, the unit can also be stored outdoors, as bad weather and rapid changes in temperature do not harm the environment provided that the electric, cooling and hydraulic circuits of the unit are intact and closed.

WEEE INFORMATION

The manufacturer is registered on the EEE National Register, in compliance with implementation of Directive 2012/19/EU and relevant national regulations on waste electrical and electronic equipment.

This Directive requires electrical and electronic equipment to be disposed of properly.

Equipment bearing the crossed-out wheellie bin mark must be disposed of separately at the end of its life cycle to prevent damage to human health and to the environment.

Electrical and electronic equipment must be disposed of together with all of its parts.

To dispose of “household” electrical and electronic equipment, the manufacturer recommends you contact an authorised dealer or an authorised ecological area.

“Professional” electrical and electronic equipment must be disposed of by authorised personnel through established waste disposal authorities around the country.

In this regard, here is the definition of household WEEE and professional WEEE:

WEEE from private households: WEEE originating from private households and WEEE which comes from commercial, industrial, institutional and other sources which, because of its nature and quantity, is similar to that from private households. Subject to the nature and quantity, where the waste from EEE was likely to have been by both a private household and users of other than private households, it will be classed as private household WEEE;

Professional WEEE: all WEEE which comes from users other than private households.

This equipment may contain:

refrigerant gas, the entire contents of which must be recovered in suitable containers by specialised personnel with the necessary qualifications;

- lubrication oil contained in compressors and in the cooling circuit to be collected;
- mixtures with antifreeze in the water circuit, the contents of which are to be collected;
- mechanical and electrical parts to be separated and disposed of as authorised.

When machine components to be replaced for maintenance purposes are removed or when the entire unit reaches the end of its life and needs to be removed from the installation, waste should be separated by its nature and disposed of by authorised personnel at existing collection centres.



General

In this section the most common situations are indicated, as these cannot be controlled by the manufacturer and could be a source of risk situations for people or things.

Danger zone

This is an area in which only an authorised operator may work.

The danger zone is the area inside the unit which is accessible only with the deliberate removal of protections or parts thereof.

Handling

The handling operations, if implemented without all of the protection necessary and without due caution, may cause the drop or the tipping of the unit with the consequent damage, even serious, to persons, things or the unit itself.

Handle the unit following the instructions provided in the present manual re-garding the packaging and in compliance with the local regulations in force.

Should the refrigerant leak please refer to the refrigerant "Safety sheet".

Installation

The incorrect installation of the unit could cause water leaks, condensate accumulation, leaking of the refrigerant, electric shock, poor operation or damage to the unit itself.

Check that the installation has been implemented by qualified technical personnel only and that the instructions contained in the present manual and the local regulations in force have been adhered to.

The installation of the unit in a place where even infrequent leaks of inflammable gas and the accumulation of this gas in the area surrounding the area occur could cause explosions or fires.

Carefully check the positioning of the unit.

The installation of the unit in a place unsuited to support its weight and/or guarantee adequate anchorage may result in consequent damage to things, people or the unit itself.

Carefully check the positioning and the anchoring of the unit.

Easy access to the unit by children, unauthorised persons or animals may be the source of accidents, some serious.

Install the unit in areas which are only accessible to authorised person and/or provide protection against intrusion into the danger zone.

General risks

Smell of burning, smoke or other signals of serious anomalies may indicate a situation which could cause damage to people, things or the unit itself.

Electrically isolate the unit (yellow-red isolator).

Contact the authorised service centre to identify and resolve the problem at the source of the anomaly.

Accidental contact with exchange batteries, compressors, air delivery tubes or other components may cause injuries and/or burns.

Always wear suitable clothing including protective gloves to work inside the danger zone.

Maintenance and repair operations carried out by non-qualified personnel may cause damage to persons, things or the unit itself.

Always contact the qualified assistance centre.

Failing to close the unit panels or failure to check the correct tightening of all of the panelling fixing screws may cause damage to persons, things or the unit itself.

Periodically check that all of the panels are correctly closed and fixed.

If there is a fire the temperature of the refrigerant could reach values that increase the pressure to beyond the safety valve with the consequent possible projection of the refrigerant itself or explosion of the circuit parts that remain isolated by the closure of the tap.

Do not remain in the vicinity of the safety valve and never leave the refrigerating system taps closed.

Electric parts

An incomplete attachment line to the electric network or with incorrectly sized cables and/or unsuitable protective devices can cause electric shocks, intoxication, damage to the unit or fires.

Carry out all of the work on the electric system referring to the electric layout and the present manual ensuring the use of a system thereto dedicated.

An incorrect fixing of the electric components cover may lead to the entry of dust, water etc inside and may consequently electric shocks, damage to the unit or fires.

Always fix the unit cover properly.

When the metallic mass of the unit is under voltage and is not correctly connected to the earthing system it may be as source of electric shock and electrocution.

Always pay particular attention to the implementation of the earthing system connections.

Contact with parts under voltage accessible inside the unit after the removal of the guards can cause electric shocks, burns and electrocution.

Open and padlock the general isolator prior to removing the guards and signal work in progress with the appropriate sign.

Contact with parts that could be under voltage due to the start up of the unit may cause electric shocks, burns and electrocution.

When voltage is necessary for the circuit open the isolator on the attachment line of the unit itself, padlock it and display the appropriate warning sign.

Moving parts

Contact with the transmissions or with the fan aspiration can cause injuries.

Prior to entering the inside of the unit open the isolator situated on the connection line of the unit itself, padlock and display the appropriate warning sign.

Contact with the fans can cause injury.

Prior to removing the protective grill or the fans, open the isolator on the attachment line of the unit itself, padlock it and display the appropriate warning sign.

Refrigerant

The intervention of the safety valve and the consequent expulsion of the gas refrigerant may cause injuries and intoxication.

Always wear suitable clothing including protective gloves and eyeglasses for operations inside the danger zone.

Should the refrigerant leak please refer to the refrigerant "Safety sheet".

Contact between open flames or heat sources with the refrigerant or the heating of the gas circuit under pressure (e.g. during welding operations) may cause explosions or fires.

Do not place any heat source inside the danger zone.

The maintenance or repair interventions which include welding must be carried out with the system off.

Hydraulic parts

Defects in tubing, the attachments or the removal parts may cause a leak or water projection with the consequent damages to people, things or shortcircuit the unit.

This feature allows up to 16 units to be connected.
 The system is completely controlled by the Master unit.
 Each connected module is identified by an address, from 0 to 15: the Master unit is identified as 0.
 The TW leaving water temperature control probe, the flow switch and the auxiliary electric heater must be controlled by the master unit.
 All units must be electrically connected to each other via the X-Y-E BUS.
 Each module can be equipped with an inertial system storage tank.
 Each unit with DHW option must have its own DHW storage.
 An external pumping unit sized for the entire capacity of the modular system must be provided (by the Customer). The pumping unit will be managed by the Master unit through a potential-free contact and 0-10V signal.
 The TW probe must be installed on the supply line of the unit, as far away as possible.

Bus comunicazione unità modulare

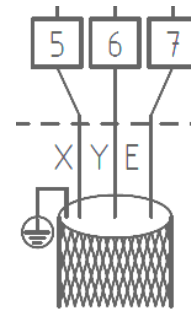

TW probe



System diagram with inverted return connection

collettori di ingresso e di uscita

Cooling (Kw)		Water pipe IN-OUT
Min	Max	
15	30	DN40
30	90	DN50
90	130	DN65
130	210	DN80
210	325	DN100
325	510	DN125
510	740	DN150
740	1300	DN200
1300	2080	DN250

Single/multiple pump system

Set up the DIP S12-2 according to the type of system.

Single water pump

The retaining valve is not necessary with this configuration.

The pump control is only activated on the master unit

Multiple water pumps.

A retaining valve for each unit is necessary with this configuration.

Pump control is activated on each unit.

Single water pumps.

dip S12-2 = OFF

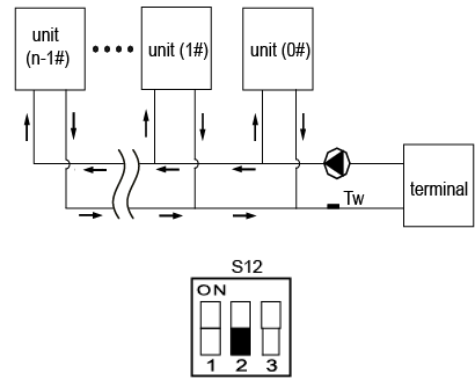

Multiple water pumps.

dip S12-2 = ON

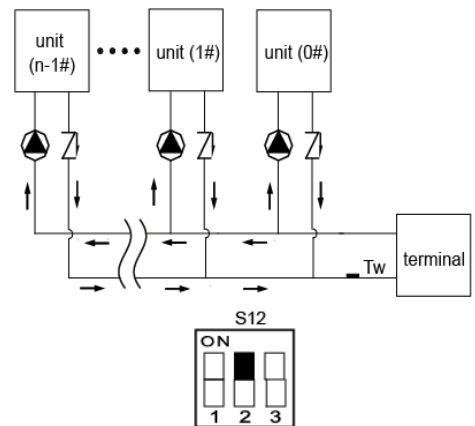

MODULAR CONFIGURATION UNITS

Set the correct date and time on each unit before connecting them to the network.

Set multiple configuration on each unit.

SW12-2 :

ON unit on modular configuration (or enabling DHW menu)

OFF single unit

The modular configuration is made up of two networks: the controller network and the unit network (main keypads).

Each network can have max 16 addresses (0 to 15) and must be addressed separately.

Each network has its own master, which must have address = 0.

If some of the slave units do not have the DHW option:

- configure a unit without a DHW option as the master.
- assign the higher addresses to the slave units equipped with DHW option

Unit addressing

Addressing is carried out through encoder ENC4 on the back of the keypad.

The address corresponds to the number on the encoder

The address is shown on the display DSP1.

E.g.:

MASTER : address = 0 encoder = 0

SLAVE 1 : address = 1 encoder = 1

SLAVE 15 : address = 15 encoder = F

The address of the unit is shown on display “DSP1” on the main keypad.

Addressing controls

A maximum of 16 controls can be addressed, with address from 0 to 15; so for example :

- 16 units with relative controller on board, il master con indirizzo 0, gli slave, the master with address 0, the slave, in read-only mode, with subsequent ones
- 15 units with relative controller on board + a remote controller as the master

Press MENU + ► for 3 seconds

Press ▲ ▼ to select the address

Remote ON-OFF

With the units in modular configuration, remote control must be applied to the master unit, which transmits it to the slave units.

Modular unit communication bus

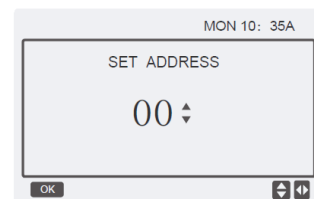
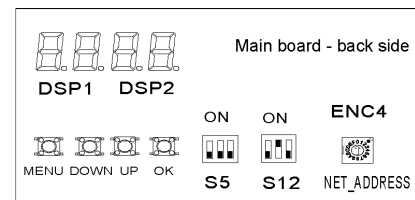
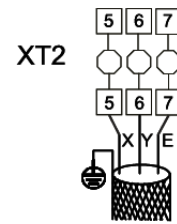

START-UP

Complete system management is carried out by the master unit, identified by address 0.

Thermoregulation takes place on the supply temperature of the entire system (T_w).

At switch-on, when a load is requested, the units are switched on in sequence based on their address, in numerical order.

When the load decreases, the units are switched off following the same sequence.

Example in cooling:

If $T_w \geq \text{set point} + 10^\circ\text{C}$

- the control activates 50% of the resources in sequence based on the set address.
- after a time interval (default: 240 seconds)
- if the load increases, additional resources are activated
- if the load decreases, the units are switched off following the same sequence (first start, first stop).

If $T_w < \text{set point} + 10^\circ\text{C}$ (in cooling)

- the control activates only the master unit.
- after a time interval (default: 240 seconds)
- if the load increases, additional resources are activated based on the set address
- if the load decreases, the master unit switches off.

General technical data

Performance

SIZE		10.1	12.1	14.1	16.2	18.2	22.2	30.2	35.2	40.2
Radiant panels										
Heating										
Heating capacity (EN 14511:2018)	1,8 kW	25,3	28,2	32,0	48,6	54,0	62,0	77,5	86,0	96,1
COP (EN 14511:2018)	2	4,17	4,25	4,16	4,01	4,01	3,90	4,15	4,01	3,75
ErP Space Heating Energy Class - AVERAGE Climate - W35	7	A++	A++	A++	A++	A++	A++	A++	A++	A++
SCOP - MEDIUM climate- W35	9	4,30	4,25	4,24	3,91	3,90	3,87	4,07	4,06	4,04
$\eta_{s,h}$ - MEDIUM climate - W35	11 %	169	167	167	153	153	152	160	159	159
SCOP - COLD climate - W35	9	3,03	3,14	3,13	2,88	2,88	2,88	3,20	3,17	3,22
$\eta_{s,h}$ - COLD climate- W35	11 %	118	123	122	112	112	112	125	124	126
SCOP - HOT climate - W35	9	4,26	4,32	4,31	3,81	3,82	3,85	4,11	4,09	3,94
$\eta_{s,h}$ - HOT climate - W35	11 %	167	170	169	149	150	151	162	160	155
Cooling										
Cooling capacity (EN 14511:2018)	4,8 kW	29,9	34,6	38,9	57,7	66,0	75,6	95,4	112	119
EER (EN 14511:2018)	5	4,28	3,94	3,62	3,83	3,53	3,23	3,88	3,41	3,29
Water flow-rate	4 l/s	1,43	1,66	1,86	2,76	3,15	3,61	4,51	5,27	5,66
User side exchanger pressure drops	4 kPa	40	50	63	37	49	62	56,0	76,5	86,2
Terminal units										
Heating										
Heating capacity (EN 14511:2018)	3 kW	24,3	27,1	31,4	48,6	54,0	62,0	73,4	84,0	97,3
COP (EN 14511:2018)	2	3,30	3,27	3,20	3,32	3,26	3,10	3,19	3,19	3,09
Cooling										
Cooling capacity (EN 14511:2018)	6 kW	22,3	25,8	29,0	42,0	48,0	55,0	68,9	79,8	88,4
EER (EN 14511:2018)	5	3,02	2,84	2,80	2,69	2,63	2,64	3,09	2,81	2,65
SEER	9	4,63	4,64	4,63	4,00	3,99	4,01	4,14	4,04	3,94
$\eta_{s,c}$	12 %	182	183	182	157	157	157	163	159	155
SEPR	10	6,12	6,1	6,09	5,64	5,61	5,47	6,14	5,81	5,63
Water flow-rate	6 l/s	1,06	1,23	1,39	2,01	2,29	2,63	3,22	3,81	4,25
User side exchanger pressure drops	6 kPa	23	29	41	28	32	36	31,5	42,4	52,2

The Product is compliant with the ErP (Energy Related Products) European Directive. It includes the Commission delegated Regulation (EU) No 811/2013 (rated heat output \leq 70 kW at specified reference conditions) and the Commission delegated Regulation (EU) No 813/2013 (rated heat output \leq 400 kW at specified reference conditions)
Contains fluorinated greenhouse gases (GWP 675)

1. Entering/leaving water temperature user side 30/35 °C, Entering external exchanger air temperature 7 °C (R.H. = 85%)
2. COP (EN 14511:2018) Heating performance coefficient. Ratio between delivered heating capacity and power input in compliance with EN 14511:2018. The overall power absorbed is calculated by adding the power absorbed by the compressor + the power absorbed by the fan - the percentage value of the fan to overcome external pressure drop + the power absorbed by the pump - the percentage value of the pump to overcome pressure drop outside + the power absorbed by the auxiliary electrical circuit
3. Entering/leaving water temperature user side 40/45 °C, Entering external exchanger air temperature 7 °C (R.H. = 85%)
4. Entering/leaving water temperature user side 23/18 °C, Entering external exchanger air temperature 35 °C
5. EER (EN 14511:2018) cooling performance coefficient. Ratio between delivered cooling capacity and power input in compliance with EN 14511:2018. The overall power absorbed is calculated by adding the power absorbed by the compressor + the power absorbed by the fan - the percentage value of the fan to overcome external pressure drop + the power absorbed by the pump - the percentage value of the pump to overcome pressure drop outside + the power absorbed by the auxiliary electrical circuit.
6. User side entering/leaving water temperature 12/7 °C, external exchanger entering air 35 °C
7. Seasonal Space Heating Energy Efficiency Class according to Commission delegated Regulation (EU) No 811/2013. W = Water outlet temperature (°C)
8. Data referred to unit operation with inverter frequency optimized for this application.
9. Data calculated according to the EN 14825:2016 Regulation
10. Seasonal energy efficiency in heating EN 14825:2018
11. Seasonal energy efficiency in cooling EN 14825:2018

Construction

SIZE		10.1	12.1	14.1	16.2	18.2	22.2	30.2	35.2	40.2
Compressor										
Type of compressors		Rotary Inverter					Scroll inverter			
Refrigerant							R32			
No. of compressors	Nr	1	1	1	2	2	2	2	2	2
Oil charge	l	2,3	2,3	2,3	4,6	4,6	4,6	6	6	6
Refrigerant Charge	Kg	7,9	7,9	7,9	14	14	14	17,5	17,5	17,5
No. of circuits	Nr	1	1	1	1	1	1	1	1	1
User side exchanger										
Type of internal exchanger	1	PHE								
Water content	l	2,44	2,44	2,44	5,17	5,17	5,17	7,8	7,8	7,8
External Section Fans										
Type of fans							Brushless DC			
No. of fans		1	1	1	2	2	2	3	3	3
Standard airflow	m ³ /h	12500	12500	12500	24000	24000	24000	10417	10417	10417
Installed unit power	kW	0,75	0,75	0,75	1,2	1,2	1,2	0,9	0,9	0,9
Water circuit										
Maximum water side pressure	kPa	1000	1000	1000	1000	1000	1000	1000	1000	1000
Minimum circuit water volume in heating	l	171	178	185	326	340	358	620	620	620
Minimum circuit water volume in cooling	l	70	75	80	140	145	150	200	200	200
Total internal water volume	l	5,44	5,44	5,44	10,3	10,3	10,3	6	6	6
Power supply										
Standard power supply							400/3/50+N			

1. PHE = plate exchanger

Sound levels - Standard mode

SIZE	Sound power level								Sound pressure level	Sound power level
	Octave band (Hz)									
	63	125	250	500	1000	2000	4000	8000	dB(A)	dB(A)
10.1	63	65	68	71	72	67	60	48	59	75
12.1	62	69	70	72	73	68	62	51	60	76
14.1	69	69	70	73	74	69	63	51	61	77
16.2	66	75	74	78	78	72	65	54	64	81
18.2	65	73	76	78	78	74	66	56	65	82
22.2	66	73	76	78	78	74	66	56	65	82
30.2	73	69	73	76	80	75	69	57	65	82
35.2	85	86	79	76	80	75	69	57	65	83
40.2	88	89	82	76	80	75	69	59	66	83

Sound levels refer to units with full load under nominal test conditions.
The sound pressure level refers to a distance of 1 meter from the outer surface of the unit operating in open field.

Sound levels - Silenced mode

SIZE	Sound power level								Sound pressure level	Sound power level
	Octave band (Hz)									
	63	125	250	500	1000	2000	4000	8000	dB(A)	dB(A)
10.1	65	65	67	70	71	70	60	49	58	74
12.1	65	65	67	70	71	70	60	49	58	74
14.1	65	65	67	70	71	70	60	49	58	74
16.2	58	67	67	69	70	68	60	52	57	74
18.2	58	67	67	69	70	68	60	52	57	74
22.2	58	67	67	69	70	68	60	52	57	74
30.2	63	68	71	71	71	68	56	58	58	75
35.2	63	68	71	71	71	68	56	58	58	75
40.2	63	68	71	71	71	68	56	58	58	75

Sound levels - Super silenced mode

SIZE	Sound power level								Sound pressure level	Sound power level
	Octave band (Hz)									
	63	125	250	500	1000	2000	4000	8000	dB(A)	dB(A)
10.1	51	62	64	68	68	63	56	45	55	71
12.1	51	62	64	68	68	63	56	45	55	71
14.1	51	62	64	68	68	63	56	45	55	71
16.2	54	67	63	66	66	65	58	51	54	71
18.2	54	67	63	66	66	65	58	51	54	71
22.2	54	67	63	66	66	65	58	51	54	71
30.2	55	74	71	68	66	66	64	55	55	73
35.2	55	74	71	68	66	66	64	55	55	73
40.2	55	74	71	68	66	66	64	55	55	73

Sound levels refer to units with maximum test conditions.
For maximum capacity supplied in silent mode, a correction factor of 0,90 shall be used.
The sound pressure level refers to a distance of 1 meter from the outer surface of the unit operating in open field.
Noise levels are determined using the tensiometric method (UNI EN ISO 9614-2)

Data referred to the following conditions in cooling:
- internal exchanger water = 12/7°C
- ambient temperature 35°C

Sound levels - At maximum conditions

SIZE	Sound power level								Sound pressure level dB(A)	Sound power level dB(A)
	Octave band (Hz)									
	63	125	250	500	1000	2000	4000	8000		
10.1	63	67	72	75	76	71	64	54	63	79
12.1	63	67	72	75	76	71	64	54	63	79
14.1	63	67	72	75	76	71	64	54	63	79
16.2	68	74	79	79	81	76	69	59	67	84
18.2	68	74	79	79	81	76	69	59	67	84
22.2	68	74	79	79	81	76	69	59	67	84
30.2	88	89	82	76	80	75	69	59	66	84
35.2	88	89	82	76	80	75	69	59	66	84
40.2	88	89	82	76	80	75	69	59	66	84

Sound levels refer to units with maximum test conditions.

For maximum capacity supplied in silent mode, a correction factor of 0,90 shall be used.

The sound pressure level refers to a distance of 1 meter from the outer surface of the unit operating in open field.

Noise levels are determined using the tensiometric method (UNI EN ISO 9614-2)

Data referred to the following conditions in heating:

- internal exchanger water = 30/35°C

- ambient temperature 7/6 °C

Overload and control device calibrations

		OPEN	CLOSE	VALUE
Refrigerant side				
High pressure safety pressure switch	kPa	4200	3200	-
Low pressure safety switch	kPa	140	300	-
Gas-liquid separator safety valve	kPa	-	-	4500
Compressor discharge high temperature safety thermostat	°C	75	115	-
Water side				
Antifreeze protection	°C	8	4	-
High pressure safety valve	kPa	-	-	600

Operating range

Cooling - Size 10.2 - 40.2

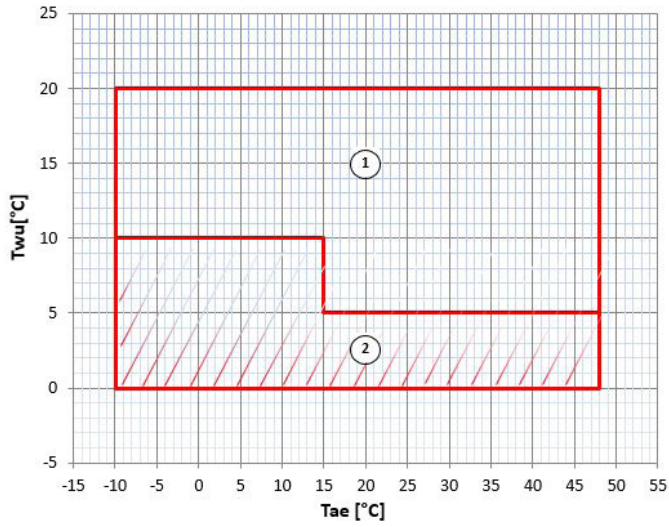

T_{wu} [°C] = Leaving exchanger water temperature
T_{ae} [°C] = External exchanger inlet air temperature

1. Normal operating range.
2. Operating range where the use of ethylene glycol is mandatory in relation to the temperature of the water at the outlet of the user side exchanger.

Heating - Size 10.2 - 22.2

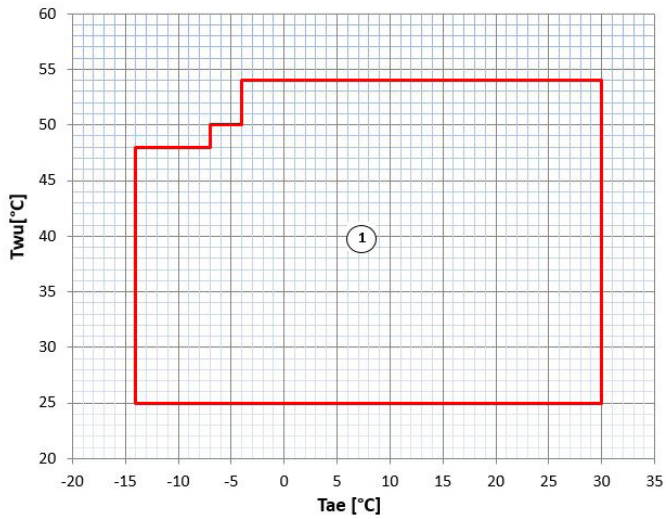

T_{wu} [°C] = Leaving exchanger water temperature
T_{ae} [°C] = External exchanger inlet air temperature

1. Normal operating range.

Heating - Size 30.2 - 40.2

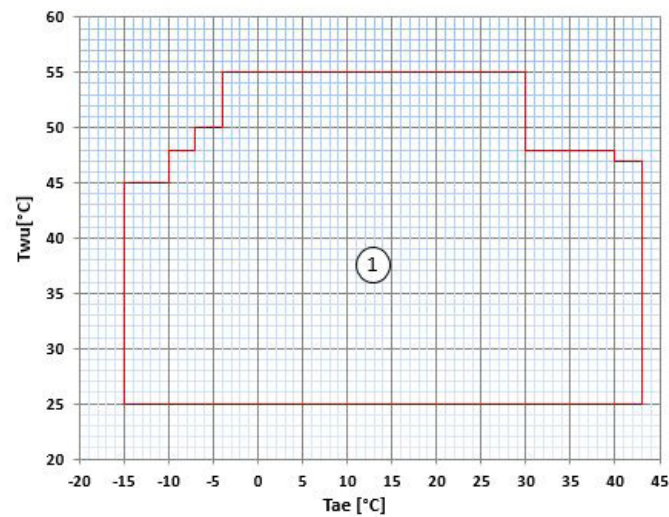

T_{wu} [°C] = Leaving exchanger water temperature
T_{ae} [°C] = External exchanger inlet air temperature

1. Normal operating range.

DHW - Size 10.2 - 22.2

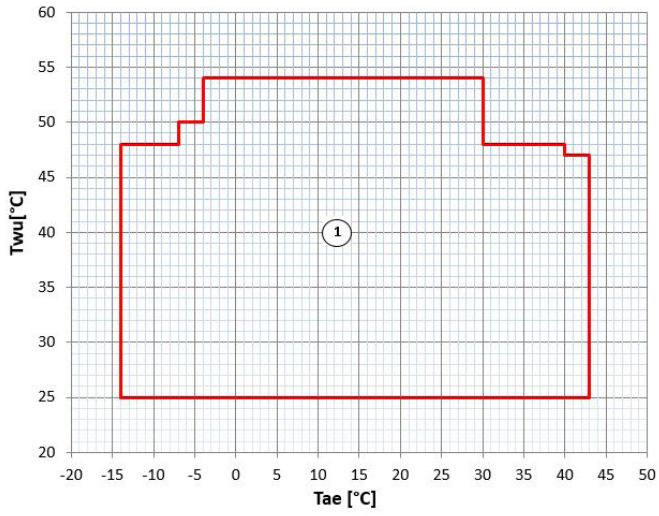

T_{wu} [°C] = Leaving exchanger water temperature
 T_{ae} [°C] = External exchanger inlet air temperature

1. Normal operating range.

DHW - Size 30.2 - 40.2

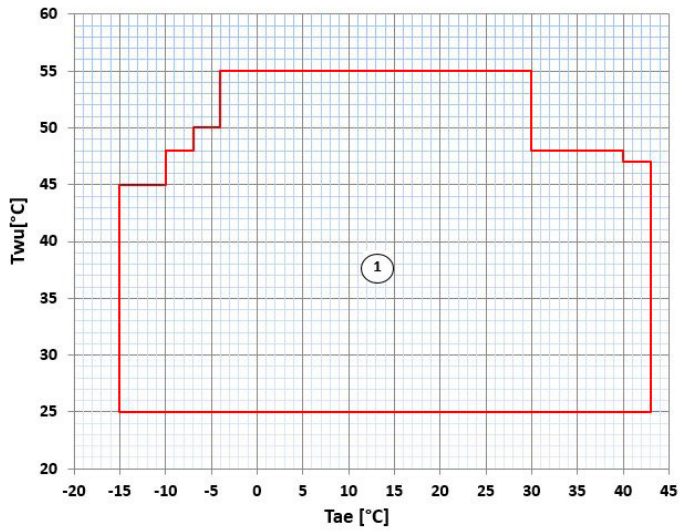

T_{wu} [°C] = Leaving exchanger water temperature
 T_{ae} [°C] = External exchanger inlet air temperature

1. Normal operating range.

Dimensional drawings

Size 10.1 - 12.1 -14.1

DABND0002_00
Data/Date 23/06/2020

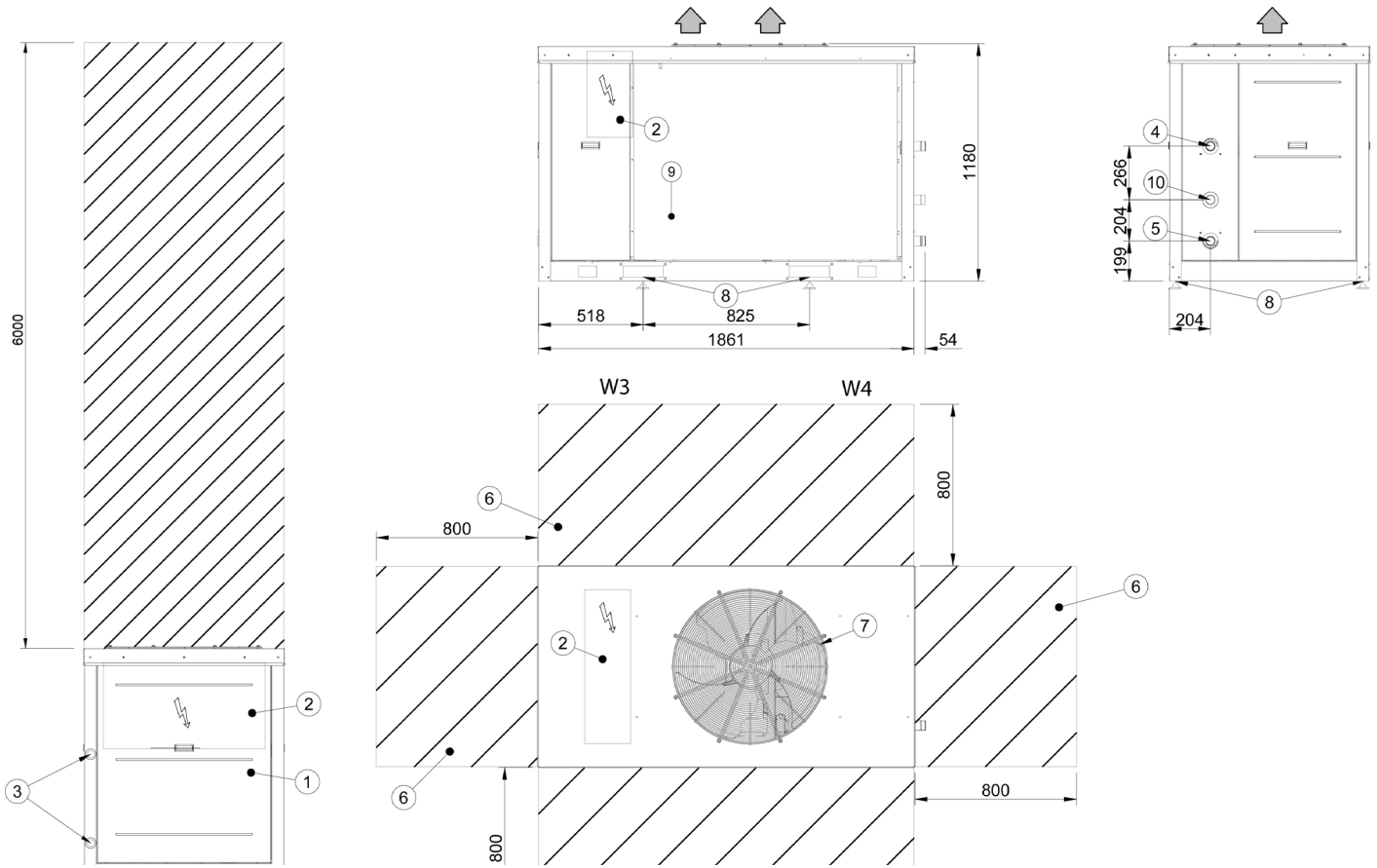

1. Compressor compartment
2. Electrical panel
3. Power input
4. Inlet water connection 1" 1/2 Victaulic
5. Outlet water connection 1" 1/2 Victaulic
6. Functional spaces
7. Electric fan
8. Unit fixing holes
9. External exchanger
10. DHW outlet (optional) 1 1/2" Victaulic

SIZE		10.1	12.1	14.1
Length	mm	1861	1861	1861
Depth	mm	991	991	991
Height	mm	1180	1180	1180
Operating weight	kg	298	298	298
Shipping weight	kg	298	298	298

The presence of optional accessories may result in a substantial variation of the weights shown in the table.

Size 16.2 - 18.2 - 22.2

DABND0003_00
Data/Date 23/06/2020

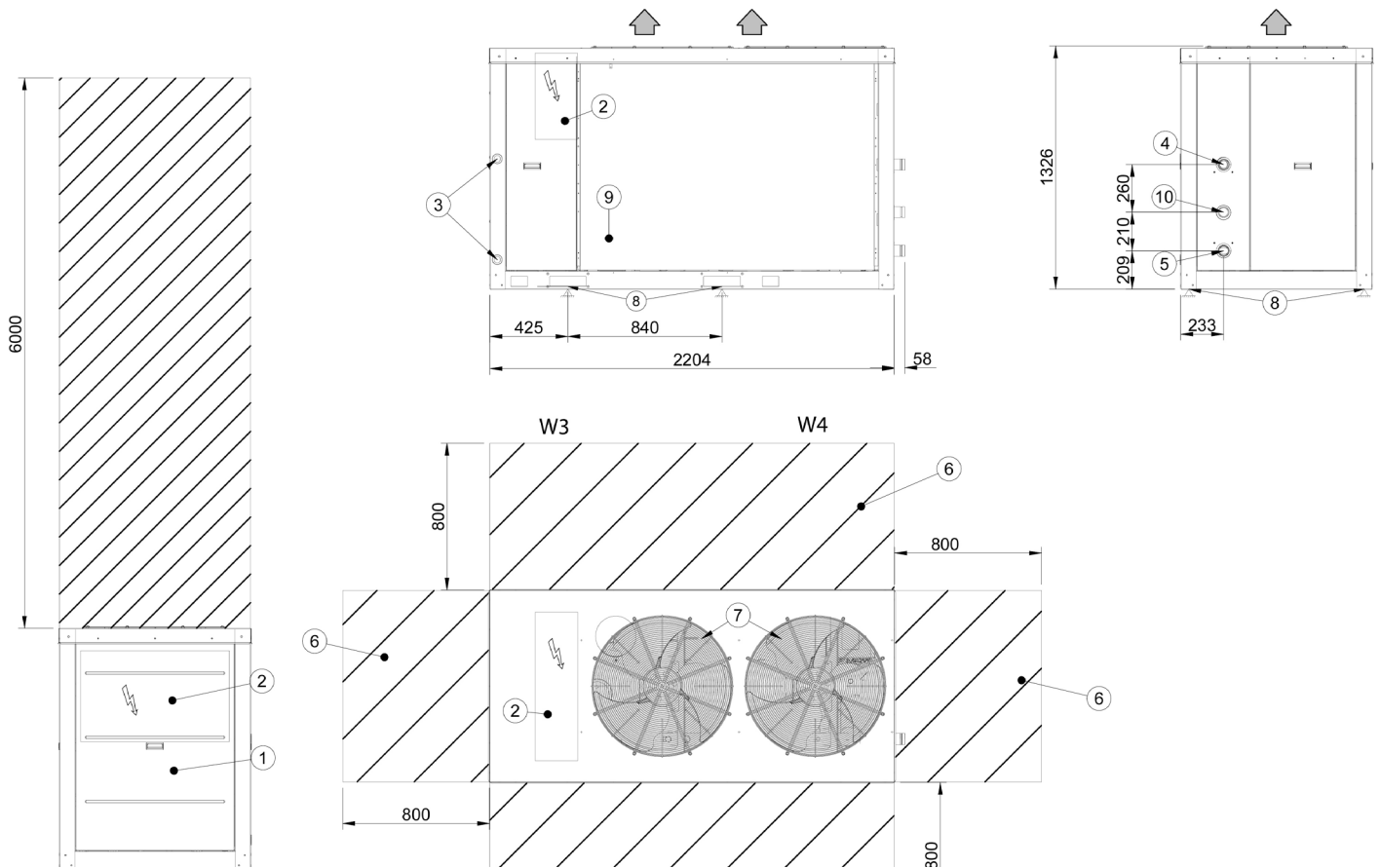

1. Compressor compartment
2. Electrical panel
3. Power input
4. Inlet water connection 2" Victaulic
5. Outlet water connection 2" Victaulic
6. Functional spaces
7. Electric fan
8. Unit fixing holes
9. External exchanger
10. DHW outlet (optional) 2" Victaulic

SIZE		16.2	18.2	22.2
Length	mm	2204	2204	2204
Depth	mm	1042	1042	1042
Height	mm	1326	1326	1326
Operating weight	kg	530	530	530
Shipping weight	kg	530	530	530

The presence of optional accessories may result in a substantial variation of the weights shown in the table.

Size 30.2 - 35.2 - 40.2

DACND0003_00
Data/Date 07/04/2021

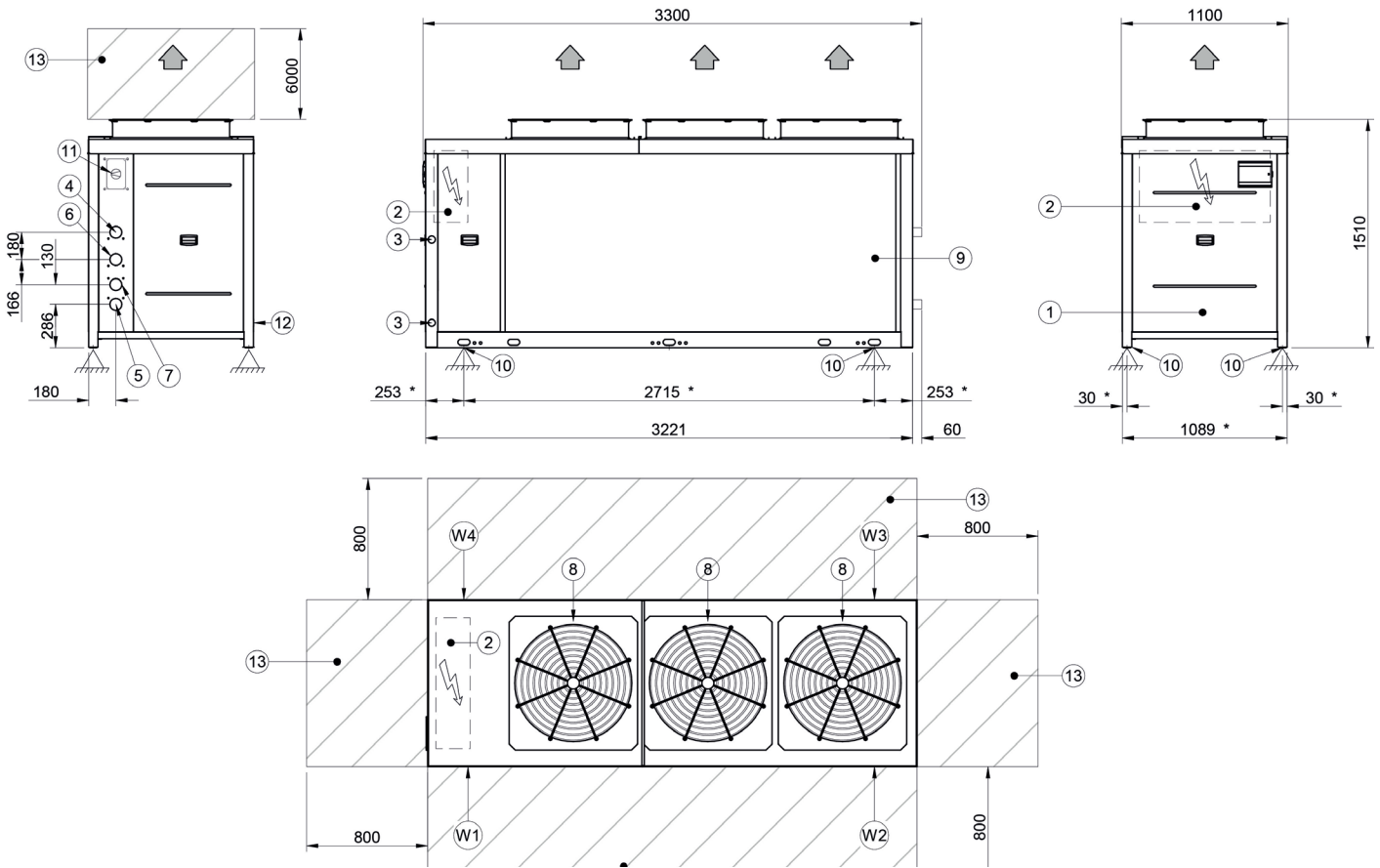

1. Compressor compartment
 2. Electrical panel
 3. Power input
 4. Inlet water connection 2" Victaulic
 5. Outlet water connection 2" Victaulic
 6. Inlet DHW connection 2" Victaulic
 7. Outlet DHW connection 2" Victaulic
 8. Electric fan
 9. External exchanger
 10. Unit fixing holes
 11. Main switch (option)
 12. Power input main switch (option)
 13. Functional spaces
- * Vibration mounts position

SIZE		30.2	35.2	40.2
Length	mm	3221	3221	3221
Depth	mm	1089	1089	1089
Height	mm	1510	1510	1510
Operating weight	kg	830	830	830
Shipping weight	kg	830	830	830

The presence of optional accessories may result in a substantial variation of the weights shown in the table.



FOR OVER 30 YEARS, WE HAVE BEEN
OFFERING SOLUTIONS TO ENSURE
SUSTAINABLE COMFORT
AND THE WELL-BEING OF PEOPLE
AND THE ENVIRONMENT



sales and assistance

www.clivet.com



CLIVET SPA

Via Camp Lonc 25, Z.I. Villapaiera

32032 Feltre (BL) - Italy

Tel. +39 0439 3131 - Fax +39 0439 313300

info@clivet.it

MideaGroup
humanizing technology